







<b>TEST REPORT</b> <b>Engineering Recommendation G99/1-6</b> <b>Requirements for the connection of generation equipment in parallel with public distribution networks on or after 27 April 2019</b>	
<b>Report</b>	
Report Number .....	6098057.53
Date of issue.....	2021-03-08
Total number of pages .....	92 pages
<b>Testing Laboratory</b> .....	DEKRA Testing and Certification (Suzhou) Co., Ltd.
Address.....	No.99, Hongye Road, Suzhou Industrial Park, Suzhou, Jiangsu, P.R. China
<b>Applicant's name</b> .....	Afore New Energy Technology (Shanghai) Co., Ltd.
Address.....	Build No.7, 333 Wanfang Road, Minhang District, Shanghai, China
<b>Test specification:</b>	
Standard .....	Engineering Recommendation G99 Issue 1 – Amendment 6: 2020
Test procedure.....	Type test
Non-standard test method.....	N/A
<b>Test Report Form No.</b> .....	G99/1-6_V1.0
Test Report Form(s) Originator .....	DEKRA Testing and Certification (Suzhou) Co., Ltd.
Master TRF.....	Dated 2020-05
<b>Test item description</b> .....	Hybrid inverter
Trade Mark .....	
Manufacturer.....	Afore New Energy Technology (Shanghai) Co., Ltd. Build No.7, 333 Wanfang Road, Minhang District, Shanghai, China
Model/Type reference .....	AF4K-SL, AF4K-SH, AF4.6K-SL, AF4.6K-SH, AF5K-SL, AF5K-SH, AF5.5K-SL, AF5.5K-SH, AF6K-SL, AF6K-SH

<b>Model / Type</b>	AF4K-SL	AF4.6K-SL	AF5K-SL	AF5.5K-SL	AF6K-SL
<b>Rating</b>	See below	See below	See below	See below	See below
<b>PV input</b>					
Max. DC voltage [V]	580				
MPPT DC voltage range [V]	50-550	50-550	50-550	50-550	50-550
Rated DC voltage [V]	360				
Input DC current [A]	20*2				
Isc PV [A]	26*2				
<b>AC output &amp; AC input</b>					
Nominal AC power [VA]	4000	4600	5000	5500	6000
Rated AC voltage [V]	230	230	230	230	230
Rated AC current [A]	17.5	20	22	24	26
Max AC current [A]	20	23	25.5	27.5	30
Frequency [Hz]	50	50	50	50	50
<b>Battery parameter</b>					
Rated voltage [V]	48				
Voltage operation range [V]	40-60				
Max charge and discharge current [A]	66	66	66	66	66
Max charge and discharge power [W]	3600	3600	3600	3600	3600
<b>EPS output</b>					
Rated output power [VA]	4000	4600	5000	5500	6000
Rated voltage [V]	230	230	230	230	230
Rated current [A]	17.5	20	22	24	26
Frequency [Hz]	50	50	50	50	50

<b>Model / Type</b>	AF4K-SH	AF4.6K-SH	AF5K-SH	AF5.5K-SH	AF6K-SH
<b>Rating</b>	See below	See below	See below	See below	See below
<b>PV input</b>					
Max. DC voltage [V]	580				
MPPT DC voltage range [V]	50-550	50-550	50-550	50-550	50-550
Rated DC voltage [V]	360				
Input DC current [A]	20*2				
Isc PV [A]	26*2				
<b>AC output &amp; AC input</b>					
Nominal AC power [VA]	4000	4600	5000	5500	6000
Rated AC voltage [V]	230	230	230	230	230
Rated AC current [A]	17.5	20	22	24	26
Max AC current [A]	20	23	25.5	27.5	30
Frequency [Hz]	50	50	50	50	50
<b>Battery parameter</b>					
Rated voltage [V]	288				
Voltage operation range [V]	85-360				
Max charge and discharge current [A]	30	30	30	30	30
Max charge and discharge power [W]	8000/4000	9000/4600	10000/5000	10000/5500	10000/6000
<b>EPS output</b>					
Rated output power [VA]	4000	4600	5000	5500	6000
Rated voltage [V]	230	230	230	230	230
Rated current [A]	17.5	20	22	24	26
Frequency [Hz]	50	50	50	50	50

Responsible Testing Laboratory (as applicable), testing procedure and testing location(s):		
<input checked="" type="checkbox"/>	Testing Laboratory:	DEKRA Testing and Certification (Suzhou) Co., Ltd.
	Testing location/ address .....	No.99, Hongye Road, Suzhou Industrial Park, Suzhou, Jiangsu, P.R. China
<input type="checkbox"/>	Associated Testing Laboratory:	
	Testing location/ address .....	
	Tested by (name, function, signature) .....	Albert Liang 
	Approved by (name, function, signature) .....	Jason Guo 
<hr/>		
<input type="checkbox"/>	Testing procedure: TMP/CTF Stage 1:	
	Testing location/ address .....	
	Tested by (name, function, signature) .....	
	Approved by (name, function, signature) .....	
<hr/>		
<input type="checkbox"/>	Testing procedure: WMT/CTF Stage 2:	
	Testing location/ address .....	
	Tested by (name + signature) .....	
	Witnessed by (name, function, signature) .....	
	Approved by (name, function, signature) .....	
<hr/>		
<input type="checkbox"/>	Testing procedure: SMT/CTF Stage 3 or 4:	
	Testing location/ address .....	
	Tested by (name, function, signature) .....	
	Witnessed by (name, function, signature) .....	
	Approved by (name, function, signature) .....	
	Supervised by (name, function, signature) .....	
<hr/>		

Copy of marking plate:



<b>Mode:</b>	3K	3.6K	4K	4.6K	5K	5.5K	6K										
<b>AFxK-SL</b>	<input type="radio"/>	<input type="radio"/>	<input type="radio"/>	<input type="radio"/>	<input type="radio"/>	<input type="radio"/>	<input type="radio"/>										
<b>Voc PV Max / d.c.V</b>	580																
<b>Vdc MPPT / d.c.V</b>	50-550																
<b>Idc Max / d.c.A</b>	20*2																
<b>Isc PV Max / d.c.A</b>	26																
<b>Pdc Max / W</b>	6600	7600	8000	8600	9000	9600	10000										
<b>Vac Nom / a.c.V</b>	230																
<b>Fac Nom / Hz</b>	50/60																
<b>Iac Nom / a.c.A</b>	13	16	17.5	20	22	24	26										
<b>Iac Max / a.c.A</b>	15	18.5	20	23	25.5	27.5	30										
<b>Sac Nom / VA</b>	3000	3600	4000	4600	5000	5500	6000										
<b>Power Factor</b>	-0.9~+0.9																
<b>EPS Vac Nom / a.c.V</b>	230																
<b>EPS Fac Nom / Hz</b>	50/60																
<b>EPS Sac / VA</b>	3000	3600	4000	4600	5000	5500	6000										
<b>Battery Type</b>	Lithium / Lead-acid																
<b>Battery Voltage Nom / V</b>	48																
<b>Battery Voltage Range / V</b>	40-60																
<b>Max. Charge Current / d.c.A</b>	60	66	66	66	66	66	66										
<b>Max. Charge/discharge Power / W</b>	3000	3600	3600	3600	3600	3600	3600										
<b>Ambient Temperature</b>	-25...60°C																
<b>Ingress Protection</b>	IP65																
<b>Inverter Topology</b>	non-isolated																
<b>Protective Class</b>	I																
<b>Over Voltage Category</b>	III(MAINS), II(PV)																
<b>Grid Monitoring</b>	IEC/EN 62109-1/-2, IEC/EN 62477-1, IEC/EN 62040-1 IEC/EN 61000-6-1, IEC/EN 61000-6-3 AS/NZS 4777.2, VDE-AR-N 4105, VDE 0126-1-1, G98, G99, NRS 097-2-1																
<b>DRM0</b>	<input checked="" type="checkbox"/>	<b>DRM1</b>	<input type="checkbox"/>	<b>DRM2</b>	<input type="checkbox"/>	<b>DRM3</b>	<input type="checkbox"/>	<b>DRM4</b>	<input type="checkbox"/>	<b>DRM5</b>	<input type="checkbox"/>	<b>DRM6</b>	<input type="checkbox"/>	<b>DRM7</b>	<input type="checkbox"/>	<b>DRM8</b>	<input type="checkbox"/>
<b>S/N</b>	03.608000310148v0.02							 <b>RoHS</b>									
<b>T</b> +86-21-54326236 <b>F</b> +86-21-54326136 <b>W</b> www.aforeenergy.com <b>E</b> info@aforeenergy.com		Afore New Energy Technology (Shanghai) Co., Ltd. Building 7, No.333 Wanfang Rd, Minhang District, Shanghai, China. 201112															



<b>Mode:</b>	3K	3.6K	4K	4.6K	5K	5.5K	6K
<b>AFxK-SH</b>	<input type="radio"/>	<input type="radio"/>	<input type="radio"/>	<input type="radio"/>	<input type="radio"/>	<input type="radio"/>	<input type="radio"/>
<b>Voc PV Max / d.c.V</b>	580						
<b>Vdc MPPT / d.c.V</b>	50-550						
<b>Idc Max / d.c.A</b>	20*2						
<b>Isc PV Max / d.c.A</b>	26						
<b>Pdc Max / W</b>	6600	8000	8000	10000	10000	10000	10000
<b>Vac Nom / a.c.V</b>	230						
<b>Fac Nom / Hz</b>	50/60						
<b>Iac Nom / a.c.A</b>	13	16	17.5	20	22	24	26
<b>Iac Max / a.c.A</b>	15	18.5	20	23	25.5	27.5	30
<b>Sac Nom / VA</b>	3000	3600	4000	4600	5000	5500	6000
<b>Power Factor</b>	-0.9~+0.9						
<b>EPS Vac Nom / a.c.V</b>	230						
<b>EPS Fac Nom / Hz</b>	50/60						
<b>EPS Sac / VA</b>	3000	3600	4000	4600	5000	5500	6000
<b>Battery Type</b>	Lithium / Lead-acid						
<b>Battery Voltage Nom / V</b>	288						
<b>Battery Voltage Range / V</b>	85-360						
<b>Max. Charge Current / d.c.A</b>	30	30	30	30	30	30	30
<b>Max. Charge/discharge Power / W</b>	6k/3k	7k/3k6	8k/4k	9k/4k6	10k/5k	10k/5k5	10k/6k
<b>Ambient Temperature</b>	-25...60 C						
<b>Ingress Protection</b>	IP65						
<b>Inverter Topology</b>	non-isolated						
<b>Protective Class</b>	I						
<b>Over Voltage Category</b>	III(MAINS), II(PV)						
<b>Grid Monitoring</b>	IEC/EN 62109-1/-2, IEC/EN 62477-1, IEC/EN 62040-1 IEC/EN 61000-6-1, IEC/EN 61000-6-3 AS/NZS 4777.2, VDE-AR-N 4105, VDE 0126-1-1, G98,G99, NRS 097-2-1						
<b>DRM0</b>	<input checked="" type="checkbox"/>	<input type="checkbox"/>	<input type="checkbox"/>	<input type="checkbox"/>	<input type="checkbox"/>	<input type="checkbox"/>	<input type="checkbox"/>
<b>DRM1</b>	<input type="checkbox"/>	<input type="checkbox"/>	<input type="checkbox"/>	<input type="checkbox"/>	<input type="checkbox"/>	<input type="checkbox"/>	<input type="checkbox"/>
<b>DRM2</b>	<input type="checkbox"/>	<input type="checkbox"/>	<input type="checkbox"/>	<input type="checkbox"/>	<input type="checkbox"/>	<input type="checkbox"/>	<input type="checkbox"/>
<b>DRM3</b>	<input type="checkbox"/>	<input type="checkbox"/>	<input type="checkbox"/>	<input type="checkbox"/>	<input type="checkbox"/>	<input type="checkbox"/>	<input type="checkbox"/>
<b>DRM4</b>	<input type="checkbox"/>	<input type="checkbox"/>	<input type="checkbox"/>	<input type="checkbox"/>	<input type="checkbox"/>	<input type="checkbox"/>	<input type="checkbox"/>
<b>DRM5</b>	<input type="checkbox"/>	<input type="checkbox"/>	<input type="checkbox"/>	<input type="checkbox"/>	<input type="checkbox"/>	<input type="checkbox"/>	<input type="checkbox"/>
<b>DRM6</b>	<input type="checkbox"/>	<input type="checkbox"/>	<input type="checkbox"/>	<input type="checkbox"/>	<input type="checkbox"/>	<input type="checkbox"/>	<input type="checkbox"/>
<b>DRM7</b>	<input type="checkbox"/>	<input type="checkbox"/>	<input type="checkbox"/>	<input type="checkbox"/>	<input type="checkbox"/>	<input type="checkbox"/>	<input type="checkbox"/>
<b>DRM8</b>	<input type="checkbox"/>	<input type="checkbox"/>	<input type="checkbox"/>	<input type="checkbox"/>	<input type="checkbox"/>	<input type="checkbox"/>	<input type="checkbox"/>
<b>S/N</b>	03.608000310100v0.02						
				<b>RoHS</b>			
<b>T</b>	+86-21-54326236	<b>F</b>	+86-21-54326136	<b>Afore New Energy Technology (Shanghai) Co., Ltd.</b>			
<b>W</b>	www.aforeenergy.com	<b>E</b>	info@aforeenergy.com	Building 7, No.333 Wanfang Rd, Minhang District, Shanghai, China. 201112			

As Great Britain public Low Voltage Distribution Networks grid code G99 required, only 230 Vac / 50Hz output setting was verified in this test report. And this report only for the generator which is greater than 16 A per phase.

<b>Test item particulars:</b>				
Equipment mobility .....	movable <u>fixed</u>	hand-held transportable	stationary for building-in	
Connection to the mains .....	<u>pluggable equipment</u> permanent connection		direct plug-in for building-in	
Environmental category .....	<u>outdoor</u>	indoor unconditional	indoor conditional	
Over voltage category Mains .....	OVC I	OVC II	<u>OVC III</u>	OVC IV
Over voltage category PV .....	OVC I	<u>OVC II</u>	OVC III	OVC IV
Mains supply tolerance (%) .....	-80% / +119%			
Tested for power systems .....	TN			
IT testing, phase-phase voltage (V).....	N/A			
Class of equipment .....	<u>Class I</u> Not classified	Class II	Class III	
Mass of equipment (kg).....	22 kg			
Pollution degree .....	Outside PD3; Inside PD2			
IP protection class.....	IP65			
<b>Possible test case verdicts:</b>				
- test case does not apply to the test object .....	N/A			
- test object does meet the requirement .....	P (Pass)			
- test object does not meet the requirement .....	F (Fail)			
- this clause is information reference for installation.:	Info.			
<b>Testing:</b>				
Date of receipt of test item .....	2020-04-15 (samples provided by applicant)			
Date (s) of performance of tests.....	2020-04-25 to 2020-06-29			
<b>General remarks:</b>				
The test results presented in this report relate only to the object tested.				
This report shall not be reproduced, except in full, without the written approval of the Issuing testing laboratory.				
The measurement result is considered in conformance with the requirement if it is within the prescribed limit. It is not necessary to account the uncertainty associated with the measurement result.				
The information provided by the customer in this report may affect the validity of the results, the test lab is not responsible for it.				
This report is not used for social proof function in China market.				
"(see Enclosure #)" refers to additional information appended to the report.				
"(see appended table)" refers to a table appended to the report.				
Throughout this report a <input type="checkbox"/> comma / <input checked="" type="checkbox"/> point is used as the decimal separator.				

**Name and address of factory (ies):**

Afore New Energy Technology (Shanghai) Co., Ltd.

Build No.7, 333 Wanfang Road, Minhang District, Shanghai, China

**General product information:**

The products are single phase hybrid inverter which converts DC voltage (from array and/or storage batteries) into AC voltage, and charge the storage batteries from the power of the PV array or grid.

The unit is providing EMC filtering at the input and output towards mains. The output was switched off redundant by the high power switching bridge and two relays in series. This assures that the opening of the output circuit will also operate in case of one error.

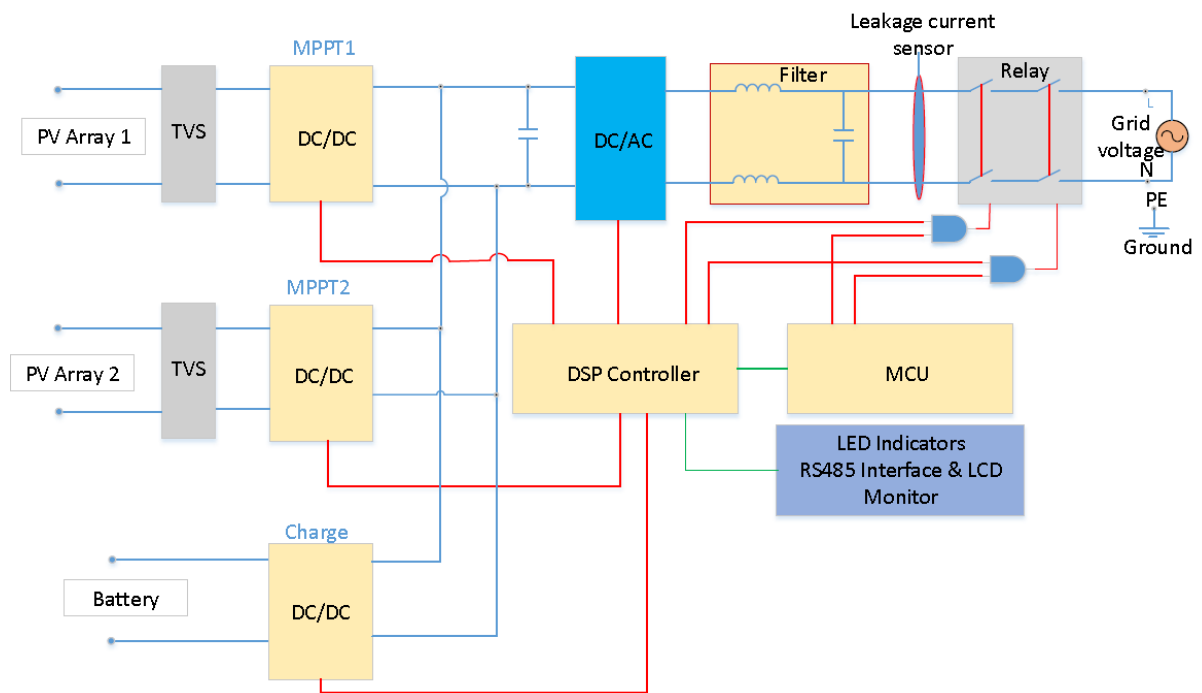
**Block Diagram:****Description of the electrical circuit and functional safety (redundancy control):**

The internal control is redundant built. It consists out of two Microcontroller DSP, the master DSP can control the relays, measures voltage, frequency, AC current with injected DC, insulation resistance and residual current. The slave DSP can control the relay, measures the voltage and frequency. Both microcontrollers communicate with each other.

The voltage and frequency measurement were performed with resistors in serial that were connected directly to line and neutral. Both controllers get these signals and analyse the data.

The unit provides two relays in series in both line and neutral. The relays are test before each start up. In addition, the power bridge can be stopped by both DSP.

The product operating temperature range: -10°C to +50°C

**Model difference:**

In the model name, the suffix SH have below meaning:

“SH” means the product with higher battery voltage.

All the models SL series are classified as one family due to they are identical in software and similar in



hardware except different battery voltage and different electrical ratings.

**The product was tested on:**

If no special state, the tests were performed on model AF6K-SL also applicable for all other models stated in this report.

Hardware version:

V03.

Software version:

DSP:1.00

**Amendment 1 report:**

The original report No. 6076145.50 issued by DEKRA Testing and Certification (Suzhou) Co., Ltd. dated on 2020-07-21 was updated and including below modifications which were considered as technical modifications:

--- The model reference of HNS4000HS, HNS4000HS-HV, HNS4600HS, HNS4600HS-HV, HNS5000HS, HNS5000HS-HV, HNS5500HS, HNS5500HS-HV, HNS6000HS, HNS6000HS-HV were changed to AF4K-SL, AF4K-SH, AF4.6K-SL, AF4.6K-SH, AF5K-SL, AF5K-SH, AF5.5K-SL, AF5.5K-SH, AF6K-SL, AF6K-SH;

---The rating labels in page 5 and page 6 were updated accordingly.

After reviewing and evaluated, no test was considered necessary.

G99/1-6			
Clause	Requirement - Test	Result - Remark	Verdict
6	Connection Application		-
6.1	General		-
6.1.1	This document describes the processes that shall be adopted for both connection of a single Power Generating Module and installations that comprise of a number of Power Generating Modules.		Info.
6.1.2	Type A Power Generating Module(s) $\leq$ 16A per phase and EREC G98 compliant	Type A Power Generating Module(s) > 16A.	N/A
6.1.2.1	A connection procedure to facilitate the connection and operation of Fully Type Tested Power Generating Modules with aggregate Registered Capacity of less than or equal to 16 A per phase in parallel with public Low Voltage Distribution Network is given in EREC G98 and is not considered further in this document. These are referred to as micro-generators.		N/A
6.1.3	Power Park Modules		P
6.1.3.1	Where an installation comprises a single Generating Unit, the application process, technical and commissioning requirements are based on the Registered Capacity of that Generating Unit. Where an installation comprises multiple Generating Units the application process, technical and commissioning requirements will generally be based on the Registered Capacity of each Power Park Module, and also on the extent to which each Power Park Module is Type Tested.		P
6.1.3.2	Where a new Generating Unit is connected to an existing installation the treatment of the addition will depend on the EREC under which the existing installation was connected. If the existing installation was connected under EREC G59 or EREC G83 then the new Generating Unit will be treated as a separate Power Park Module and managed for compliance with this EREC G99 as a separate Power Generating Module. If, however, the existing installation was completed in compliance with EREC G98 or EREC G99, then the new Power Park Module must be added to the aggregate capacity of the complete installation which must be used to determine which EREC is applicable irrespective of technology.		P
6.1.4	Synchronous Power Generating Modules	Not Synchronous Power Generating Modules.	N/A
6.1.4.1	Where an installation comprises a single Synchronous Power Generating Module or multiple Synchronous Power Generating Modules, the application process, technical and commissioning requirements are based on the Registered Capacity of each Synchronous Power Generating Module.		N/A

G99/1-6			
Clause	Requirement - Test	Result - Remark	Verdict
6.1.4.2	Where one or more new Synchronous Power Generating Module(s) is to be connected to an existing installation then each new Power Generating Module will be treated as a separate Synchronous Power Generating Module. Only the new Power Generating Module will be required to meet the requirements of this EREC G99 or EREC G98 if applicable. However, note that if the aggregated capacity of all the Power Generating Modules in the Power Generating Facility (ie the Registered Capacity of the Power Generating Facility) reaches the threshold for large as defined in the Grid Code (ie 10 MW in the north of Scotland; 30 MW in the south of Scotland, 100 MW in England and Wales), then the Generator will have to ensure compliance with relevant parts of the Grid Code. Similarly if the Registered Capacity of a Power Generating Facility in England and Wales is 50 MW or more, the Generator will have to comply with paragraphs 6.4.4 and 13.8.		N/A
6.1.5	Illustrative examples		Info.
6.1.5.1	Table 6.1 is provided to illustrate some of the connection scenarios and the EREC requirements.		Info.
6.1.5.2	In respect of Table 6.1 the aggregate Registered Capacity of all the Power Generating Modules in the Power Generating Facility will be taken into account when the DNO considers the effect of the connection on the Distribution Network.		Info.

G99/1-6																														
Clause	Requirement - Test	Result - Remark	Verdict																											
	<p align="center"><b>Table 6.1 Examples of connection scenarios</b></p> <table border="1"> <thead> <tr> <th>Details of the existing <b>Power Generating Facility</b></th> <th>Planned expansion to the <b>Power Generating Facility</b></th> <th>Compliance requirements</th> </tr> </thead> <tbody> <tr> <td>Nil</td> <td><b>Type A Generating Unit(s)</b></td> <td>The unit(s) comprise a new <b>Power Generating Module</b> for compliance EREC G99<sup>4</sup>.</td> </tr> <tr> <td><b>Synchronous Power Generating Modules</b> commissioned under EREC G83 or EREC G59</td> <td><b>Synchronous Power Generating Modules</b> Figure 6.1</td> <td>Original and additional <b>Power Generating Modules</b> treated separately. Only additional <b>Power Generating Modules</b> need to comply with EREC G99; the entire <b>Power Generating Facility</b> needs to comply with operational requirements.</td> </tr> <tr> <td><b>Synchronous Power Generating Modules</b> commissioned under EREC G98 or EREC G99</td> <td><b>Synchronous Power Generating Modules</b> Figure 6.2</td> <td>Original and additional <b>Power Generating Modules</b> treated separately. All <b>Power Generating Modules</b> need to comply with EREC G99<sup>5</sup> and with operational requirements.</td> </tr> <tr> <td><b>Synchronous Power Generating Modules</b> commissioned under EREC G83 or EREC G59 and <b>Synchronous Power Generating Modules</b> commissioned under EREC G98 or EREC G99</td> <td><b>Synchronous Power Generating Modules</b> Figure 6.3</td> <td>Original and additional <b>Power Generating Modules</b> treated separately. Additional <b>Power Generating Modules</b> need to comply with EREC G99; all need to comply with operational requirements.</td> </tr> <tr> <td><b>Power Park Module</b> commissioned under EREC G83 or EREC G59</td> <td><b>Asynchronous Power Generating Units</b> Figure 6.4</td> <td>New units form a new <b>Power Park Module</b>. Original and additional <b>Power Park Modules</b> treated separately. Only additional <b>Power Park Modules</b> need to comply with EREC G99; all need to comply with operational requirements.</td> </tr> <tr> <td><b>Power Park Module</b> commissioned under EREC G98 or EREC G99</td> <td><b>Asynchronous Power Generating Units</b> Figure 6.5</td> <td>Units aggregated to form a new single <b>Power Generating Module</b>. Compliance required for the new module size, with EREC G99 and with operational requirements.</td> </tr> <tr> <td><b>Power Park Module</b> commissioned under EREC G98 or EREC G99</td> <td>Storage DC coupled (ie connected to the existing <b>Inverters</b> with no change to <b>Inverters</b>) Figure 6.6</td> <td>No compliance effect. Compliance remains based on existing <b>Inverters</b>, ie on the existing <b>Power Park Module</b>. The <b>Generator</b> must, under their <b>Connection Agreement</b> apply to the <b>DNO</b> before connecting the new storage.</td> </tr> <tr> <td><b>Power Park Module</b> commissioned under EREC G98 or EREC G99</td> <td>Storage AC coupled – ie storage Figure 6.7</td> <td>The new storage units form an independent <b>Power Park Module</b> which needs to comply with EREC G99, although is exempt from certain requirements as listed in Annex A4.</td> </tr> </tbody> </table>	Details of the existing <b>Power Generating Facility</b>	Planned expansion to the <b>Power Generating Facility</b>	Compliance requirements	Nil	<b>Type A Generating Unit(s)</b>	The unit(s) comprise a new <b>Power Generating Module</b> for compliance EREC G99 <sup>4</sup> .	<b>Synchronous Power Generating Modules</b> commissioned under EREC G83 or EREC G59	<b>Synchronous Power Generating Modules</b> Figure 6.1	Original and additional <b>Power Generating Modules</b> treated separately. Only additional <b>Power Generating Modules</b> need to comply with EREC G99; the entire <b>Power Generating Facility</b> needs to comply with operational requirements.	<b>Synchronous Power Generating Modules</b> commissioned under EREC G98 or EREC G99	<b>Synchronous Power Generating Modules</b> Figure 6.2	Original and additional <b>Power Generating Modules</b> treated separately. All <b>Power Generating Modules</b> need to comply with EREC G99 <sup>5</sup> and with operational requirements.	<b>Synchronous Power Generating Modules</b> commissioned under EREC G83 or EREC G59 and <b>Synchronous Power Generating Modules</b> commissioned under EREC G98 or EREC G99	<b>Synchronous Power Generating Modules</b> Figure 6.3	Original and additional <b>Power Generating Modules</b> treated separately. Additional <b>Power Generating Modules</b> need to comply with EREC G99; all need to comply with operational requirements.	<b>Power Park Module</b> commissioned under EREC G83 or EREC G59	<b>Asynchronous Power Generating Units</b> Figure 6.4	New units form a new <b>Power Park Module</b> . Original and additional <b>Power Park Modules</b> treated separately. Only additional <b>Power Park Modules</b> need to comply with EREC G99; all need to comply with operational requirements.	<b>Power Park Module</b> commissioned under EREC G98 or EREC G99	<b>Asynchronous Power Generating Units</b> Figure 6.5	Units aggregated to form a new single <b>Power Generating Module</b> . Compliance required for the new module size, with EREC G99 and with operational requirements.	<b>Power Park Module</b> commissioned under EREC G98 or EREC G99	Storage DC coupled (ie connected to the existing <b>Inverters</b> with no change to <b>Inverters</b> ) Figure 6.6	No compliance effect. Compliance remains based on existing <b>Inverters</b> , ie on the existing <b>Power Park Module</b> . The <b>Generator</b> must, under their <b>Connection Agreement</b> apply to the <b>DNO</b> before connecting the new storage.	<b>Power Park Module</b> commissioned under EREC G98 or EREC G99	Storage AC coupled – ie storage Figure 6.7	The new storage units form an independent <b>Power Park Module</b> which needs to comply with EREC G99, although is exempt from certain requirements as listed in Annex A4.		Info.
Details of the existing <b>Power Generating Facility</b>	Planned expansion to the <b>Power Generating Facility</b>	Compliance requirements																												
Nil	<b>Type A Generating Unit(s)</b>	The unit(s) comprise a new <b>Power Generating Module</b> for compliance EREC G99 <sup>4</sup> .																												
<b>Synchronous Power Generating Modules</b> commissioned under EREC G83 or EREC G59	<b>Synchronous Power Generating Modules</b> Figure 6.1	Original and additional <b>Power Generating Modules</b> treated separately. Only additional <b>Power Generating Modules</b> need to comply with EREC G99; the entire <b>Power Generating Facility</b> needs to comply with operational requirements.																												
<b>Synchronous Power Generating Modules</b> commissioned under EREC G98 or EREC G99	<b>Synchronous Power Generating Modules</b> Figure 6.2	Original and additional <b>Power Generating Modules</b> treated separately. All <b>Power Generating Modules</b> need to comply with EREC G99 <sup>5</sup> and with operational requirements.																												
<b>Synchronous Power Generating Modules</b> commissioned under EREC G83 or EREC G59 and <b>Synchronous Power Generating Modules</b> commissioned under EREC G98 or EREC G99	<b>Synchronous Power Generating Modules</b> Figure 6.3	Original and additional <b>Power Generating Modules</b> treated separately. Additional <b>Power Generating Modules</b> need to comply with EREC G99; all need to comply with operational requirements.																												
<b>Power Park Module</b> commissioned under EREC G83 or EREC G59	<b>Asynchronous Power Generating Units</b> Figure 6.4	New units form a new <b>Power Park Module</b> . Original and additional <b>Power Park Modules</b> treated separately. Only additional <b>Power Park Modules</b> need to comply with EREC G99; all need to comply with operational requirements.																												
<b>Power Park Module</b> commissioned under EREC G98 or EREC G99	<b>Asynchronous Power Generating Units</b> Figure 6.5	Units aggregated to form a new single <b>Power Generating Module</b> . Compliance required for the new module size, with EREC G99 and with operational requirements.																												
<b>Power Park Module</b> commissioned under EREC G98 or EREC G99	Storage DC coupled (ie connected to the existing <b>Inverters</b> with no change to <b>Inverters</b> ) Figure 6.6	No compliance effect. Compliance remains based on existing <b>Inverters</b> , ie on the existing <b>Power Park Module</b> . The <b>Generator</b> must, under their <b>Connection Agreement</b> apply to the <b>DNO</b> before connecting the new storage.																												
<b>Power Park Module</b> commissioned under EREC G98 or EREC G99	Storage AC coupled – ie storage Figure 6.7	The new storage units form an independent <b>Power Park Module</b> which needs to comply with EREC G99, although is exempt from certain requirements as listed in Annex A4.																												
6.1.6	Interaction with the NETSO		P																											
6.1.6.1	It should be noted that if the Registered Capacity of all Power Generating Module (synchronous together with asynchronous) on one or more sites in common ownership is >50 MW, then the Generator becomes licensable.		Info.																											
6.1.6.2	Generators with an agreement with the NETSO may be required to comply with applicable requirements of the Grid Code. Where Grid Code requirements apply, it is the Generator's responsibility to comply with the relevant parts of both the Distribution Code and Grid Code.		P																											
6.2	Application for Connection		P																											

G99/1-6			
Clause	Requirement - Test	Result - Remark	Verdict
6.2.1	Information about the Power Generating Module(s) is needed by the DNO so that it can assess the effect that a Power Generating Facility may have on the Distribution Network. This document details the parameters to be supplied by a Generator wishing to connect Power Generating Module(s) that do not comply with EREC G98 to a Distribution Network. This document also enables the DNO to request more detailed information if required.		P
6.2.2	Integrated Micro Generation and Storage procedure		N/A
6.2.2.1	<p>The Generator may wish to install Integrated Micro Generation and Storage. Where all of the following conditions apply, the Integrated Micro Generation and Storage procedure can be followed:</p> <ul style="list-style-type: none"> <li>■ The Power Generating Modules are located in a single Generator's Installation;</li> <li>■ The total aggregate capacity of the Power Generating Modules (including Electricity Storage devices) is between 16 A and 32 A per phase;</li> <li>■ The total aggregate capacity of the Power Generating Modules that are Electricity Storage devices does not exceed 16 A per phase and the total aggregate capacity of the Power Generating Modules that are not Electricity Storage devices does not exceed 16 A per phase. Note that if the total aggregated capacity of Electricity Storage and non- Electricity Storage devices is no greater than 16 A per phase, the single premises procedure described in EREC G98 applies;</li> <li>■ All of the Power Generating Modules (including Electricity Storage devices) are connected via EREC G98 Fully Type Tested Inverters;9</li> <li>■ An EREC G100 compliant export limitation scheme is present that limits the export from the Generator's Installation to the Distribution Network to 16 A per phase; and</li> <li>■ The Power Generating Modules will not operate when there is a loss of mains situation.</li> </ul>		N/A
6.2.2.2	If all the conditions in 6.2.2.1 are satisfied, the Generator should complete an application in a format as shown in Form A1-2 (Annex A.1). Otherwise the Generator should refer to the connection application procedure for Type A Power Generating Modules.		N/A

G99/1-6			
Clause	Requirement - Test	Result - Remark	Verdict
6.2.2.3	The planned commissioning date stated on the application form shall be within 10 working days and 3 months from the date that the application is submitted to the DNO. Confirmation of the commissioning of each Power Generating Module shall be made no later than 28 days after commissioning (where tests and checks are not witnessed). Confirmation shall be provided in a format as shown in Form A3-2 (Annex A.3). In addition to Form A3-2, an EREC G100 Export Limitation Scheme Installation and Commissioning Tests form shall be submitted to the DNO to confirm that the Export Limitation Scheme meets the requirements set out in EREC G100. Confirmation shall be provided in a format as shown in EREC G100 Appendix B.		N/A
6.2.2.4	Note that a number of sections of EREC G98 do not apply to Electricity Storage devices that are covered by this procedure. Refer to Appendix 1 of EREC G98 for details.		N/A
6.2.3	Power Generating Facilities which include Type A Power Generating Modules		P
6.2.3.1	For Type A Power Generating Modules the compliance, testing and commissioning requirements are detailed in Section 16 of this EREC G99.	Type A Power Generating Modules.	P
6.2.3.2	The Generator should apply to the local DNO for connection using the DNO's Standard Application Form (available from the DNO's website). On receipt of the application, the DNO will assess whether any Distribution Network studies are required and whether there is a requirement to witness the commissioning tests. In some cases studies to assess the impact on the Distribution Network may need to be undertaken before a firm quotation can be provided to the Generator. On acceptance of the quote, any works at the connection site and any associated facilitating works will need to be completed before the Power Generating Module can be commissioned. On successful completion of the commissioning tests, the DNO will sanction permanent energisation of the Power Generating Module in accordance with Section 16 of this EREC G99.		P
6.2.4	Power Generating Facilities which include Type B, Type C or Type D Power Generating Modules	Type A Power Generating Modules	N/A
6.3	System Analysis for Connection Design Type A, Type B, Type C and Type D		Info.
6.4	Provision of Information		Info.
7	Connection Arrangements		P
7.1	Operating Modes		P

G99/1-6			
Clause	Requirement - Test	Result - Remark	Verdict
7.1.1	Power Generating Modules may be designed for one of three operating modes. These are termed long-term parallel operation, infrequent short-term parallel operation and switched alternative-only operation. In the case that a Power Generating Module is designed to switch between these modes of operation, it must be designed to comply with the requirements for each mode.	Long-Term Parallel Operation.	P
7.1.2	Equipment other than Generating Units (eg traction loads, lift motors etc) may act as a short term source of energy, and inject electrical energy into the Customer's Installation when they operate in a regenerative mode. In general EREC G99 will not apply as there will be no need to make any specific design accommodation for such equipment as it is unlikely that they will support any possible power island for a significant length of time. Where such equipment can act as a source of electrical energy for more than a few seconds (say typically 20 s), the DNO will advise the Customer if the Customer's Installation requires any special consideration such as reverse power protection on a case by case basis.		N/A
7.2	Long-Term Parallel Operation		P
7.2.1	This refers to the frequent or long-term operation of Power Generating Modules in parallel with the Distribution Network. Unless otherwise stated, all sections in this EREC G99 are applicable to this mode of operation.		P
7.3	Infrequent Short-Term Parallel Operation	Long-Term Parallel Operation.	N/A
7.3.1	This mode of operation typically enables Power Generating Modules to operate as a standby to the DNOs supply. A short-term parallel is required to maintain continuity of supply during changeover and to facilitate testing of the Power Generating Module.		N/A
7.3.2	In this mode of operation, parallel operation of the Power Generating Module and the Distribution Network will be infrequent and brief and under such conditions, it is considered acceptable to relax certain design requirements, such as protection requirements, that would be applicable to long-term parallel operation. The provisions of this Section 7 should also be read with Annex A.4 which details some other specific exclusions of parts of Sections 9 to 12 of this EREC G99.		N/A
7.3.3	As the design requirements for Power Generating Module operating in this mode are relaxed compared with those for long-term parallel operation, it is necessary for the DNO to specify a maximum frequency and duration of short-term parallel operation, to manage the risk associated with the relaxed design requirement.		N/A

G99/1-6			
Clause	Requirement - Test	Result - Remark	Verdict
7.3.4	The following design variations from those in the remainder of this EREC G99 are appropriate for infrequent short-term parallel operation:		N/A
7.3.5	Some Manufacturers have developed fast acting automatic transfer switches. These are devices that only make a parallel connection for a very short period of time, typically 100 – 200 ms. Under these conditions installing conventional Interface Protection with an operating time of 500 ms is not appropriate when the parallel will normally be broken before the protection has a chance to operate. There is however the risk that the device will fail to operate correctly and therefore a timer should be installed to operate a conventional circuit breaker if the parallel remains on for more than 1 s. The switch should be inhibited from making a transfer to the DNO's Distribution Network whilst voltage and frequency are outside expected limits.		N/A
7.4	Switched Alternative-Only Operation	Long-Term Parallel Operation.	N/A
7.5	Phase Balance of Type A Power Generating Module output at LV		P
7.5.1	Connection of single phase Power Generating Modules may require Distribution Network reinforcement and extension before commissioning for technical reasons (such as voltage issues and unacceptable phase imbalance) depending on the point of connection and Distribution Network design.		P
7.5.2	A solution to these voltage issues and phase imbalance issues may be to utilise 3-phase Power Generating Modules or to use multiple single phase Power Generating Modules connected across three phases.	Single phase PV inverter not used in three phase system.	N/A
7.5.3	Where single phase Power Generating Modules are being used the Generator should design the installation on a maximum unbalance output of 16 A between the highest and lowest phase.	Single phase PV inverter not used in three phase system.	N/A
7.5.4	In order to illustrate this requirement examples of acceptable and unacceptable connections have been given in Annex A.5.		Info.
7.6	Type A Power Generating Module capacity for single and split LV phase supplies		P
7.6.1	The maximum aggregate capacity of Power Generating Modules that can be connected to a single phase supply is 17 kW. The maximum aggregate capacity of Power Generating Modules that can be connected to a split single phase supply is 34 kW.	Single phase PV inverter with max output power 5 kW.	P



G99/1-6			
Clause	Requirement - Test	Result - Remark	Verdict
7.6.2	There is no requirement to provide intertripping between single phase Inverters where these are installed on multi-phase supplies up to a limit of 17 kW per phase (subject to balance of site output as per Section 7.5). A single phase 17 kW connection may result in an imbalance of up to 17 kW following a Distribution Network or Power Generating Module outage. However the connection design should result in imbalance under normal operation to be below 16 A between phases as noted above.	Single phase PV inverter not used in three phase system.	N/A
7.6.3	Power Generating Facilities with a capacity above 17 kW per phase are expected to comprise three phase units. The requirement to disconnect all phases following a fault in the Generator's Installation or a Distribution Network outage applies to three phase the Power Generating Modules only and will be tested as part of the compliance testing of the Power Generating Module. In some parts of the country where provision of three phase networks is costly then the DNO may be able to provide a solution using single or split phase networks for Power Generating Facilities above the normal limits as set out above.	Single phase PV inverter not used in three phase system.	N/A
7.7	Voltage Management Units in Generator's premises		P
7.7.1	Voltage Management Units are becoming more popular and use various methods, in most cases, to reduce the voltage supplied from the DNO's Distribution Network before it is used by the Generator. In some cases where the DNO's Distribution Network voltage is low they may increase the voltage supplied to the Generator. Some technologies are only designed to reduce voltage and cannot increase the voltage.		Info.
7.7.2	The use of such equipment has the advantage to the Generator of running appliances at a lower voltage and in some cases this can reduce the energy consumption of the appliance. Some appliances when running at a lower voltage will result in higher current consumption as the device needs to take the same amount of energy from the system to carry out its task.		Info.
7.7.3	If a Voltage Management Unit is installed between the Connection Point and the Power Generating Module in a Generators Installation, it may result in the voltage at the Generator side of the Voltage Management Unit remaining within the limits of the protection settings defined in Table 10.1 while the voltage at the Connection Point side of the unit might be outside the limits of the protection settings. This would negate the effect of the protection settings. Therefore, this connection arrangement is not acceptable and all Power Generating Modules connected to the DNO's LV Distribution Network under this Engineering Recommendation must be made on the Connection Point side of any Voltage Management Unit installed in a Generator's Installation.		N/A

G99/1-6			
Clause	Requirement - Test	Result - Remark	Verdict
7.7.4	Generators should note that the overvoltage setting defined in Table 10.1 is 4% above the maximum voltage allowed for the voltage from the DNO's Distribution Network under the ESQCR and that provided they have designed their installation correctly there should be very little nuisance tripping of the Power Generating Module. Frequent nuisance tripping of a Power Generating Module may be due to a fault in the Generator's Installation or the operation of the DNO's Distribution Network at too high a voltage. Generators should satisfy themselves that their installation has been designed correctly and all Power Generating Modules are operating correctly before contacting the DNO if nuisance tripping continues. Under no circumstances should they resort to the use of Voltage Management Units installed between the Connection Point and the Power Generating Module.		P
8	Earthing		P
8.1	General		P
8.1.1	The earthing arrangements of the Power Generating Module shall satisfy the requirements of DPC4 of the Distribution Code.		P
8.2	Power Generating Modules with a Connection Point at HV	Power Generating Modules connected to LV.	N/A
8.3	Power Generating Modules with a Connection Point at LV		P
8.3.1	LV Distribution Networks are always solidly earthed, and the majority are multiple earthed. Design practice for protective multiple earthing is detailed in the Energy Networks Association publications including Engineering Recommendation G12, and in the references contained in those publications.		P
8.3.2	The winding configuration and method of earthing connection shall be agreed with the DNO.		P
8.3.3	In addition, where the Power Generation Facility's Connection Point is at Low Voltage the following shall apply: Where an earthing terminal is provided by the DNO it may be used by a Power Generation Facility for earthing the Power Generating Module, provided the DNO earth connection is of adequate capacity.		P
8.3.4	The following Figures 8.5 to 8.9 show typical installations.		Info.
9	Network Connection Design and Operation		P
9.1	General Criteria		P
9.1.1	As outlined in Section 5, DNOs have to meet certain statutory and Distribution Licence obligations when designing and operating their Distribution Networks. These obligations will influence the options for connecting Power Generating Modules.		P

G99/1-6			
Clause	Requirement - Test	Result - Remark	Verdict
9.1.2	The technical and design criteria to be applied in the design of the Distribution Network and Power Generating Module connection are detailed in this document and DPC 4 of the Distribution Code. The criteria are based upon the performance requirements of the Distribution Network necessary to meet the above obligations.		P
9.1.3	The Distribution Network, and any Power Generating Module connection to that network, shall be designed:		P
	(a) to comply with the obligations (to include security, frequency and voltage; voltage disturbances and harmonic distortion; auto reclosing and single phase protection operation).		P
	(b) according to design principles in relation to Distribution Network's plant and equipment, earthing, voltage regulation and control, and protection as outlined in DPC4, subject to any Modification to which the DNO may reasonably consent.		P
9.1.4	Power Generating Modules should meet a set of technical requirements in relation to its performance with respect to frequency and voltage, control capabilities, protection coordination requirements, Phase (Voltage) Unbalance requirements, neutral earthing provisions, islanding and Black Start Capability as applicable. The technical connection requirements in this chapter are common to all Power Generating Modules.		P
9.1.5	In addition requirements for Type A Power Generating Modules are detailed in Section 11. Requirements for Type B Power Generating Modules are detailed in Section 12. Requirements for Type C and Type D Power Generating Modules are detailed in Section 13.	Type A Power Generating Modules fulfil with Section 11.	P
9.2	Network Connection Design for Power Generating Modules		P
9.3	Step Voltage Change and Rapid Voltage Change		P
9.4	Power Quality		P
9.4.1	Introduction		P
9.4.1.1	The connection and operation of Power Generating Modules may cause Phase (Voltage) Unbalance and/or a distortion of the Distribution Network voltage waveform resulting in voltage fluctuations and harmonics.		P
9.4.2	Flicker		P
9.4.2.1	Where the input motive power of the Power Generating Module may vary rapidly, causing corresponding changes in the output power, flicker may result. The operation of a Power Generating Module including synchronisation, run-up and desynchronisation shall not result in flicker that breaches the limits for flicker that is non-compliant with EREC P28.		P

G99/1-6			
Clause	Requirement - Test	Result - Remark	Verdict
9.4.2.2	The supply impedance of the Distribution Network needs to be considered to ensure that the emissions produced by the Power Generating Module do not cause a problem on the Distribution Network.		P
9.4.2.3	For Power Generating Modules up to 17 kW per phase or 50 kW three phase voltage step change and flicker measurements as required by BS EN 61000-3-11 shall be made and recorded in the test declaration form A2-1 or form A2-3 as applicable for the Power Generating Module. The DNO will use these declared figures to calculate the required maximum supply impedance required for the connection to comply with EREC P28. This calculation may show that the voltage fluctuations will be greater than those permitted and hence reinforcement of the Distribution Network may be required before the Power Generating Module can be connected. Detailed testing requirements are described in Annex A.7.		P
9.4.3	Harmonic Emissions		P
9.4.3.1	Harmonic currents produced within the Generator's system and modification of the harmonic impedance caused by the addition of the Generator's installation may cause excessive harmonic voltage distortion in the Distribution Network. The Generator's Installation must be designed and operated to comply with the planning criteria for harmonic voltage distortion as specified in EREC G5. EREC G5, like all planning standards referenced in this recommendation, is applicable at the time of connection of additional equipment to a Generator's Installation.		P
9.4.3.2	For Power Generating Modules of up to 17 kW per phase or 50 kW three phase harmonic measurements as required by BS EN 61000-3-12 shall be made and recorded in the test declaration form A2-1 or form A2-3 as applicable for the Power Generating Module. The DNO will use these declared figures to calculate the required maximum supply impedance required for the connection to comply with BS EN 61000-3-12 and will use this data in their design of the connection for the Power Generating Module. This standard requires a minimum ratio between source fault level and the size of the Power Generating Module, and connections in some cases may require the installation of a transformer between 2 and 4 times the rating of the Power Generating Module in order to accept the connection to a DNO's Distribution Network. Detailed testing requirements are described in Annex A.7		P

G99/1-6			
Clause	Requirement - Test	Result - Remark	Verdict
9.4.3.3	Where the Power Generating Module is connected via a long cable circuit the likelihood of a resonant condition is greatly increased, especially at 132 kV. This arises from the reaction of the transformer inductance with the cable capacitance. Resonance is likely in the low multiples of the fundamental frequency (8th-11th harmonic). The resonant frequency is also a function of the Total System fault level. If there is the possibility that this can change significantly eg by the connection of another Power Generating Module then a full harmonic study should be carried out.		N/A
9.4.4	Voltage imbalance		N/A
9.4.4.1	EREC P29 is a planning standard which provides limits for voltage unbalance caused by uneven loading of three phase supply systems. Power Generating Modules should be capable of performing satisfactorily under the conditions it defines. The existing voltage unbalance on an urban Distribution Network rarely exceeds 0.5% but higher levels, in excess of 1%, may be experienced at times of high load and when outages occur at voltage levels above 11 kV. 1% may exist continuously due to unbalance of the system impedance (common on remote rural networks). In addition, account can be taken of the neutralising effect of rotating plant, particularly at 11 kV and below. BS EN 50160 contains details of the variations and disturbances to the voltage which shall be taken into account in selecting equipment from an appropriate specification for installation on or connected to the Distribution Network.	Single phase inverter.	N/A
9.4.4.2	The level of voltage unbalance at the Point Of Common Coupling should be no greater than 1.3% for systems with a nominal voltage below 33 kV, or 1% for other systems with a nominal voltage no greater than 132 kV. Overall, voltage unbalance should not exceed 2% when assessed over any one minute period. EREC P29, like all planning standards, is applicable at the time of connection.		N/A
9.4.4.3	For Power Generating Facilities of 50 kW or less Section 7.5 of this document specifies maximum unbalance of Power Generating Modules. Where these requirements are met then no further action is required by the Generator.		N/A
9.4.5	Power Factor correction equipment is sometimes used with Power Park Modules to decrease Reactive Power flows on the Distribution Network. Where the Power Factor correction equipment is of a fixed output, stable operating conditions in the event of loss of the DNO supply are extremely unlikely to be maintained, and therefore no special protective actions are required in addition to the standard protection specified in this document.		P

G99/1-6			
Clause	Requirement - Test	Result - Remark	Verdict
9.4.6	DC Injection		P
9.4.6.1	The effects of, and therefore limits for, DC currents injected into the Distribution Network is an area currently under investigation. Until these investigations are concluded the limit for DC injection is less than 0.25% of the AC rating per Power Generating Module.	See appended table.	P
9.4.6.2	The main source of these emissions are from transformer-less Inverters. Where necessary DC emission requirements can be satisfied by installing a transformer on the AC side of an Inverter.		P
9.5	System Stability		P
9.5.1	Instability in Distribution Networks may result in unacceptable quality of supply and tripping of Generator's plant. In severe cases, instability may cascade across the Distribution Network, resulting in widespread tripping and loss of demand and generation. There is also a risk of damage to plant.		P
9.5.2	In general, System Stability is an important consideration in the design of Power Generating Module connections to the Distribution Network at 33 kV and above. Stability considerations may also be appropriate for some Power Generating Module connections at lower voltages. The risks of instability generally increase as Power Generating Module capacity increases relative to the fault level infeed from the Distribution Network at the Connection Point.		P
9.5.3	System Stability may be classified into several forms, according firstly to the main system variable in which instability can be observed, and secondly to the size of the system disturbance. In Distribution Networks, the forms of stability of interest are rotor angle stability and voltage stability.		P
9.5.3.1	Rotor angle stability refers to the ability of synchronous machines in an interconnected system to remain in Synchronism after the system is subjected to a disturbance.		N/A
9.5.3.2	Voltage stability refers to the ability of a system to maintain acceptable voltages throughout the system after being subjected to a disturbance.		P
9.5.3.3	Both rotor angle stability and voltage stability can be further classified according to the size of the disturbance.		P
9.5.3.4	Small-disturbance stability refers to the ability of a system to maintain stability after being subjected to small disturbances such as small changes in load, operating points of Power Generating Modules, transformer tap-changing or other normal switching events.		P

G99/1-6			
Clause	Requirement - Test	Result - Remark	Verdict
9.5.3.5	Large-disturbance stability refers to the ability of a system to maintain stability after being subjected to large disturbances such as short-circuit faults or sudden loss of circuits or Power Generating Modules.		P
9.5.3.6	Traditionally, large-disturbance rotor angle stability (also referred to as transient stability) has been the form of stability predominantly of interest in Distribution Networks with synchronous machines. However, it should be noted that the other forms of stability may also be important and may require consideration in some cases.		P
9.5.4	It is recommended that a Power Generating Module and its connection to the Distribution Network be designed to maintain stability of the Distribution Network for a defined range of initial operating conditions and a defined set of system disturbances.		P
9.5.4.1	The range of initial operating conditions should be based on those which are reasonably likely to occur over a year of operation. Variables to consider include system loads, system voltages, system outages and configurations, and Power Generating Module operating conditions.		P
9.5.4.2	The system disturbances for which stability should be maintained should be selected on the basis that they have a reasonably high probability of occurrence. It is recommended that these include short-circuit faults on single Distribution Network circuits (such as transformers, overhead lines and cables) and busbars, that are quickly cleared by main protection.		P
9.5.5	With the system in its normal operating state, it is desirable that all Power Generation Modules remain connected and stable for any of the following credible fault outages, (a) any one single circuit overhead line, transformer feeder or cable circuit, independent of length, (b) any one transformer or reactor, (c) any single section of busbar at or nearest the point of connection where busbar protection with a total clearance time of less than 200ms is installed, (d) if demand is to be secured under a second circuit outage as required by EREC P2, fault outages (a) or (b), overlapping with any pre-existing first circuit outage, usually for maintenance purposes. In this case the combination of circuit outages considered should be that causing the most onerous conditions for System Stability, taking account of the slowest combination of main protection, circuit breaker operating times and strength of the connections to the system remaining after the faulty circuit or circuits have been disconnected.		P

G99/1-6			
Clause	Requirement - Test	Result - Remark	Verdict
9.5.6	It should be noted that it is impractical and uneconomical to design for stability in all circumstances. This may include double circuit fault outages and faults that are cleared by slow protection. Power Generating Modules that become unstable following system disturbances shall be disconnected as soon as possible to reduce the risk of plant damage and disturbance to the system.		P
9.5.7	<p>Various measures may be used, where reasonably practicable, to prevent or mitigate system instability. These may include Distribution Network and Power Generating Module solutions, such as:</p> <p>(a) from the Distribution Network at the Connection Point. improved fault clearance times by means of faster protection;</p> <p>(b) improved performance of Power Generating Module control systems (excitation and governor/prime mover control systems; Power System Stabilisers to improve damping);</p> <p>(c) improved system voltage support (provision from either Power Generating Module or Distribution Network plant);</p> <p>(d) reduced plant reactance's (if possible);</p> <p>(e) installation of protection to identify pole-slipping;</p> <p>(f) increased fault level infeed.</p> <p>In determining mitigation measures which are reasonably practicable, due consideration should be given to the cost of implementing the measures and the benefits to the Distribution Network and Generators in terms of reduced risk of system instability.</p>		P
9.6	Island Mode		P
9.6.1	A fault or planned outage, which results in the disconnection of a Power Generating Module, together with an associated section of Distribution Network, from the remainder of the Total System, creates the potential for island mode operation. It will be necessary for the DNO to decide, dependent on local network conditions, if it is desirable for the Generators to continue to generate onto the islanded DNO's Distribution Network. The key potential advantage of operating in Island Mode is to maintain continuity of supply to the portion of the Distribution Network containing the Power Generating Module. The principles discussed in this section generally also apply where Power Generating Modules on a Generator's site is designed to maintain supplies to that site in the event of a failure of the DNO supply.		P



G99/1-6			
Clause	Requirement - Test	Result - Remark	Verdict
9.6.2	When considering whether Power Generating Modules can be permitted to operate in island mode, detailed studies need to be undertaken to ensure that the islanded system will remain stable and comply with all statutory obligations and relevant planning standards when separated from the remainder of the Total System. Before operation in island mode can be allowed, a contractual agreement between the DNO and Generator must be in place and the legal liabilities associated with such operation must be carefully considered by the DNO and the Generator. Consideration should be given to the following areas:		P
	(a) load flows, voltage regulation, frequency regulation, voltage unbalance, voltage flicker and harmonic voltage distortion; (b) earthing arrangements; (c) short circuit currents and the adequacy of protection arrangements; (d) System Stability; (e) resynchronisation to the Total System; (f) safety of personnel.		P
9.6.3	Suitable equipment will need to be installed to detect that an island situation has occurred and an intertripping scheme is preferred to provide absolute discrimination at the time of the event. Confirmation that a section of Distribution Network is operating in island mode, and has been disconnected from the Total System, will need to be transmitted to the Power Generating Module(s) protection and control schemes.		P
9.6.4	The ESQCR requires that supplies to Customers are maintained within statutory limits at all times ie when they are supplied normally and when operating in island mode. Detailed system studies including the capability of the Power Generating Module and its control / protections systems will be required to determine the capability of the Power Generating Module to meet these requirements immediately as the island is created and for the duration of the island mode operation.		P
9.6.5	The ESQCR also require that Distribution Networks are earthed at all times. Generators, who are not permitted to operate their installations and plant with an earthed star-point when in parallel with the Distribution Network, must provide an earthing transformer or switched star-point earth for the purpose of maintaining an earth on the system when islanding occurs. The design of the earthing system that will exist during island mode operation should be carefully considered to ensure statutory obligations are met and that safety of the Distribution Network to all users is maintained. Further details are provided in Section 8.		P

G99/1-6			
Clause	Requirement - Test	Result - Remark	Verdict
9.6.6	Detailed consideration must be given to ensure that protection arrangements are adequate to satisfactorily clear the full range of potential faults within the islanded system taking into account the reduced fault currents and potential longer clearance times that are likely to be associated with an islanded system.		P
9.6.7	Switchgear shall be rated to withstand the voltages which may exist across open contacts under islanded conditions. The DNO may require interlocking and isolation of its circuit breaker(s) to prevent out of phase voltages occurring across the open contacts of its switchgear. Intertripping or interlocking should be agreed between the DNO and the Generator where appropriate.	It's depended on Installer.	N/A
9.6.8	It will generally not be permissible to interrupt supplies to DNO Customers for the purposes of resynchronisation. The design of the islanded system must ensure that synchronising facilities are provided at the point of isolation between the islanded network and the DNO supply. Specific arrangements for this should be agreed and recorded in the Connection Agreement with the DNO. If no facilities exist for the subsequent resynchronisation with the rest of the DNO's Distribution Network then the Generator will, under DNO instruction, ensure that the Power Generating Module is disconnected for resynchronisation.		P
9.7	Fault Contributions and Switchgear Considerations		P
10	Protection		P
10.1	General		P
10.1.1	The main function of the protection systems and settings described in this document is to prevent the Power Generating Module supporting an islanded section of the Distribution Network when it would or could pose a hazard to the Distribution Network or Customers connected to it. The settings recognize the need to avoid nuisance tripping and therefore require a two stage approach where practicable, ie to have a long time delay for smaller excursions that may be experienced during normal Distribution Network operation, to avoid nuisance tripping, but with a faster trip, where possible, for greater excursions.		P
10.1.2	In accordance with established practice it is for the Generator to install, own and maintain this protection. The Generator can therefore determine the approach, ie per Power Generating Module or per installation, and where in the installation the protection is sited.		P

G99/1-6			
Clause	Requirement - Test	Result - Remark	Verdict
10.1.3	Where a common protection system is used to provide the protection function for multiple Power Generating Modules the complete installation cannot be considered to comprise Fully Type Tested Power Generating Modules if the protection and connections are made up on site and so cannot be factory tested or Type Tested. If the units or Power Generating Modules are specifically designed to be interconnected on site via plugs and sockets, then provided the assembly passes the function tests required in Annex A.2 (Form A2-4), the Power Generating Modules can retain Type Tested status.		P
10.1.4	Type Tested Interface Protection shall have protection settings set during manufacture. An Interface Protection device or relay can only be considered Type Tested if:  (a) The frequency and LoM protection settings are factory set in firmware by the Manufacturer to those in Table 10.1 and cannot be changed outside the factory (except as provided by (e) below).  (b) The voltage protection settings are factory set to those in Table 10.1 and can be changed by agreement with the DNO and by personnel specifically instructed by the Generator to make this change.  (c) The access by the personnel specifically instructed shall be controlled by a password, pin or a physical switch that has the facility to be sealed.  (d) Any Interface Protection device functionality other than the voltage protection settings (eg such as any auto reclosing functionality) can only be changed by personnel specifically empowered to do so by the Generator.  (e) Any changes to device firmware etc, where Type Tested status is to be retained, outside of the original factory environment shall be undertaken by personnel specifically empowered and equipped for that task by the Manufacturer.		P
10.1.5	Once the Power Generating Modules has been installed and commissioned the protection settings shall only be altered following written agreement between the DNO and the Generator.		P
10.1.6	In exceptional circumstances additional protection may be required by the DNO to protect the Distribution Network and its Customers from the Power Generating Module.		P
10.1.7	Note that where the Generator installs an Export Limiting Scheme in accordance with EREC G100 the installation will also need to comply with the requirements of that EREC.		P
10.2	Co-ordinating with DNO's Distribution Network's Existing Protection		P

G99/1-6			
Clause	Requirement - Test	Result - Remark	Verdict
10.2.1	<p>It will be necessary for the protection associated with Power Generating Modules to co-ordinate with the Protection associated with the DNO's Distribution Network as follows:</p> <p>(a) For Power Generating Modules directly connected to the DNO's Distribution Network the Power Generating Module must meet the target clearance times for fault current interchange with the DNO's Distribution Network in order to reduce to a minimum the impact on the DNO's Distribution Network of faults on circuits owned by the Generator.</p> <p>The DNO will ensure that the DNO protection settings meet its own target clearance times.</p> <p>The target clearance times are measured from fault current inception to arc extinction and will be specified by the DNO to meet the requirements of the relevant part of the Distribution Network.</p> <p>(b) The settings of any protection controlling a circuit breaker or the operating values of any automatic switching device at any point of connection with the DNO's Distribution Network, as well as the Generator's maintenance and testing regime, shall be agreed between the DNO and the Generator in writing during the connection consultation process.</p>		P
	<p>It will be necessary for the Power Generating Module protection to co-ordinate with any auto-reclose policy specified by the DNO. In particular the Power Generating Module protection should detect a loss of mains situation and disconnect the Power Generating Module in a time shorter than any auto reclose dead time. This should include an allowance for circuit breaker operation and generally a minimum of 0.5 s should be allowed for this. For auto-reclosers set with a dead time of 3 s, this implies a maximum Interface Protection response time of 2.5 s. Where auto-reclosers have a dead time of less than 3 s, there may be a need to reduce the operating time of the Interface Protection. For Type Tested Power Park Modules no changes are required to the operating times irrespective of the auto-reclose times. In all other cases where the auto-recloser dead time is less than 3 s the Generator will need to agree site-specific Interface Protection settings with the DNO.</p>		P

G99/1-6			
Clause	Requirement - Test	Result - Remark	Verdict
10.2.2	<p>Specific protection required for Power Generating Modules</p> <p>In addition to any protection installed by the Generator to meet his own requirements and statutory obligations on him, the Generator must install protection to achieve the following objectives:</p> <p>(a) For all Power Generating Modules:</p> <p>i. To disconnect the Power Generating Module from the system when a system abnormality occurs that results in an unacceptable deviation of the frequency or voltage at the Connection Point, recognizing the requirements to ride through faults as detailed in Sections 12.3 and 13.4;</p> <p>ii. To ensure the automatic disconnection of the Power Generating Module, or where there is constant supervision of an installation, the operation of an alarm with an audio and visual indication, in the event of any failure of supplies to the protective equipment that would inhibit its correct operation.</p> <p>(b) For polyphase Power Generating Modules: i. To inhibit connection of Power Generating Modules to the system unless all phases of the DNO's Distribution Network are present and within the agreed ranges of protection settings;</p> <p>ii. To disconnect the Power Generating Module from the system in the event of the loss of one or more phases of the DNO's Distribution Network;</p>		P
	<p>(c) For single phase Power Generating Modules:</p> <p>i. To inhibit connection of Power Generating Modules to the system unless that phase of the DNO's Distribution Network is present and within the agreed ranges of protection settings;</p> <p>ii. To disconnect the Power Generating Module from the system in the event of the loss of that phase of the DNO's Distribution Network;</p>		P
10.3	Protection Requirements		P
10.3.1	<p>Suitable protection arrangements and settings will depend upon the particular Generator installation and the requirements of the DNO's Distribution Network. These individual requirements must be ascertained in discussions with the DNO. To achieve the objectives above, the protection must include the detection of:</p> <ul style="list-style-type: none"> <li>• Under Voltage (1 stage);</li> <li>• Over Voltage (2 stage);</li> <li>• Under Frequency (2 stage);</li> <li>• Over Frequency (1 stage);</li> <li>• Loss of Mains (LoM).</li> </ul>		P

G99/1-6			
Clause	Requirement - Test	Result - Remark	Verdict
	The LoM protection will depend for its operation on the detection of some suitable parameter, for example, rate of change of frequency (RoCoF), or unbalanced voltages. More details on LoM protection are given in Section 10.4.		P
10.3.2	The protective equipment, provided by the Generator, to meet the requirements of this section must be installed in a suitable location that affords visual inspection of the protection settings and trip indicators and is secure from interference by unauthorised personnel.		P
10.3.3	Installation of automatic reconnection systems for Type B, Type C and Type D shall be subject to prior authorisation by the DNO. Unless Generators of Type D Power Generating Modules have prior authorisation from the DNO for the installation of automatic reconnection systems, they must obtain authorisation from the DNO, or NETSO as applicable, prior to synchronisation.	Type A Power Generating Modules.	N/A
10.3.4	The frequency and voltage at the DNO's side of the supply terminals at the Connection Point must be within the frequency and voltage ranges of the Interface Protection as listed in paragraph 10.6.7 for at least 20 s before the Power Generating Module is allowed to automatically reconnect to the DNO's Distribution Network. There is in general no maximum admissible ramp rate for Active Power output on connecting or reconnecting, although it is a requirement to state the assumed maximum ramp rate for the Power Generating Module as part of the application for connection.		P
10.3.5	If automatic resetting of the protective equipment is used, there must be a time delay to ensure that healthy supply conditions exist for a minimum continuous period of 20 s. Reset times may need to be co-ordinated where more than one Power Generating Module is connected to the same feeder. The automatic reset must be inhibited for faults on the Generator's Installation.		P
10.3.6	Protection equipment is required to function correctly within the environment in which it is placed and shall satisfy the following standards: <ul style="list-style-type: none"> <li>• BS EN 61000 (Electromagnetic Standards);</li> <li>• BS EN 60255 (Electrical Relays);</li> <li>• BS EN 61810 (Electrical Elementary Relays);</li> <li>• BS EN 60947 (Low Voltage Switchgear and Control gear);</li> <li>• BS EN 61869 (Instrument Transformers; Additional requirements for current transformers).</li> </ul> Where these standards have more than one part, the requirements of all such parts shall be satisfied, so far as they are applicable.		P

G99/1-6			
Clause	Requirement - Test	Result - Remark	Verdict
10.3.7	<p>Protection equipment and protection functions may be installed within, or form part of the Power Generating Module control equipment as long as:</p> <p>(a) the control equipment satisfies all the requirements of Section 10 including the relevant standards specified in paragraph 10.3.6;</p> <p>(b) the Power Generating Module shuts down in a controlled and safe manner should there be an equipment failure that affects both the protection and control functionality, for example a power supply failure or microprocessor failure; and</p> <p>(c) the equipment is designed and installed so that protection calibration and functional tests can be carried out easily and safely using secondary injection techniques (ie using separate Low Voltage test equipment).</p>		P
10.3.8	<p>The health of protection tripping and/or auxiliary supplies must be monitored such that any failure of these supplies is either brought to the immediate attention of the Generator via an automatic alarm that is monitored by the Generator in real time, or the failure of the protection tripping and/or auxiliary supplies causes the Power Generation Module to be tripped, and reconnection prevented before restoration of the protection tripping and/or auxiliary supplies that have been lost.</p>		P
10.4	Loss of Mains (LoM)	See appended table.	P
10.4.1	<p>To achieve the objectives of Section 10.1.1, in addition to protection installed by the Generator for his own purposes, the Generator must install protection to achieve (amongst other things) disconnection of the Power Generating Module from the Distribution Network in the event of loss of one or more phases of the DNOs supply.</p>		P
10.4.2	<p>LoM protection is required for all Type A, Type B and Type C Power Generating Modules. For Type D Power Generating Modules the DNO will advise if LoM protection is required. The requirements of paragraph 10.6.2 apply to LoM protection for all Power Generating Modules.</p>		P
10.4.3	<p>A problem can arise for Generators who operate a Power Generating Module in parallel with the Distribution Network prior to a failure of the network supply because if their Power Generating Module continues to operate in some manner, even for a relatively short period of time, there is a risk that when the network supply is restored the Power Generating Module will be out of Synchronism with the Total System and suffer damage. LoM protection can be employed to disconnect the Power Generating Module immediately after the supply is lost, thereby avoiding damage to the Power Generating Module.</p>		P

G99/1-6			
Clause	Requirement - Test	Result - Remark	Verdict
10.4.4	<p>Where the amount of Distribution Network load that the Power Generating Module will attempt to pick up following a fault on the Distribution Network is significantly more than its capability the Power Generating Module will rapidly disconnect, or stall. However, depending on the exact conditions at the time of the Distribution Network failure, there may or may not be a sufficient change of load on the Power Generating Module to be able to reliably detect the failure. The Distribution Network failure may result in one of the following load conditions being experienced by the Power Generating Module:</p> <p>(a) The load may slightly increase or reduce, but remain within the capability of the Power Generating Module. There may even be no change of load;</p> <p>(b) The load may increase above the capability of the prime mover, in which case the Power Generating Module will slow down, even though the alternator may maintain voltage and current within its capacity. This condition of speed/frequency reduction can be easily detected; or</p> <p>(c) The load may increase to several times the capability of the Power Generating Module, in which case the following easily detectable conditions will occur:</p> <ul style="list-style-type: none"> <li>• Overload and accompanying speed/frequency reduction</li> <li>• Over current and under voltage on the alternator</li> </ul>		P
10.4.5	<p>Conditions (b) and (c) are easily detected by the under and over voltage and frequency protection required in this document. However, condition (a) presents most difficulty, particularly if the load change is extremely small and therefore there is a possibility that part of the Distribution Network supply being supplied by the Power Generating Module will be out of Synchronism with the Total System. LoM protection is designed to detect these conditions.</p>		P
10.4.6	<p>LoM signals can also be provided by means of intertripping signals from circuit breakers that have operated in response to the Distribution Network fault.</p>		P



G99/1-6			
Clause	Requirement - Test	Result - Remark	Verdict
10.4.7	The LoM protection can utilise one or a combination of the passive protection principles such as reverse Active Power flow, reverse Reactive Power and rate of change of frequency (RoCoF). Alternatively, active methods such as reactive export error detection or frequency shifting may be employed. These may be arranged to trip the interface circuit breaker at the DNO Generator interface, thus, leaving the Power Generating Module available to satisfy the load requirements of the site or the Power Generating Module circuit breaker can be tripped, leaving the breaker at the interface closed and ready to resume supply when the Distribution Network supply is restored. The most appropriate arrangement is subject to agreement between the DNO and Generator.		P
10.4.8	Protection based on measurement of reverse flow of Active Power or Reactive Power can be used when circumstances permit and must be set to suit the Power Generating Module rating, the site load conditions and requirements for Reactive Power.		P
10.4.9	Where the Power Generating Facility capacity is such that the site will always import power from the Distribution Network, a reverse power relay may be used to detect failure of the supply. It will usually be appropriate to monitor all three phases for reverse power.		P
10.4.10	However, where the Power Generating Facilities normal mode of operation is to export power, it is not possible to use a reverse power relay and consequently failure of the supply cannot be detected by measurement of reverse power flow. The protection should then be specifically designed to detect loss of the mains connection using techniques to detect the rate of change of frequency and/or Power Factor. All these techniques are susceptible to Distribution Network conditions and the changes that occur without islanding taking place. These relays must be set to prevent islanding but with the best possible immunity to unwanted nuisance operation.		P
10.4.11	RoCoF relays use a measurement of the period of the mains voltage cycle. The RoCoF technique measures the rate of change in frequency caused by any difference between prime mover power and electrical output power of the Power Generating Module over a number of cycles. RoCoF relays should normally ignore the slow changes but respond to relatively rapid changes of frequency which occur when the Power Generating Module becomes disconnected from the Total System. The voltage vector shift technique is not an acceptable loss of mains protection.		P

G99/1-6			
Clause	Requirement - Test	Result - Remark	Verdict
10.4.12	Should spurious tripping present a nuisance to the Generator, the cause must be jointly sought with the DNO. Raising settings on any relay to avoid spurious operation may reduce a relay's capability to detect islanding and it is important to evaluate fully such changes. Annex D.2 provides some guidance for assessments, which assume that during a short period of islanding the trapped load is unchanged. In some circumstances it may be necessary to employ a different technique, or a combination of techniques to satisfy the conflicting requirements of safety and avoidance of nuisance tripping. In those cases where the DNO requires LoM protection this must be provided by a means not susceptible to spurious or nuisance tripping, eg intertripping.		P
10.4.13	For a radial or simple Distribution Network controlled by circuit breakers that would clearly disconnect the entire circuit and associated Power Generating Module, for a LoM event an intertripping scheme can be easy to design and install. For meshed or ring Distribution Networks, it can be difficult to define which circuit breakers may need to be incorporated in an intertripping scheme to detect a LoM event and the inherent risks associated with a complex system should be considered alongside those associated with a using simple, but potentially less discriminatory LoM relay.		P
10.4.14	It is the responsibility of the Generator to incorporate what they believe to be the most appropriate technique or combination of techniques to detect a LoM event in his protection systems. This will be based on knowledge of the Power Generating Module, site and network load conditions. The DNO will assist in the decision making process by providing information on the Distribution Network and its loads. The settings applied must be biased to ensure detection of islanding under all practical operating conditions.		P
10.5	Additional DNO Protection		P
10.5.1	Following the DNO connection study, the risk presented to the Distribution Network by the connection of a Power Generating Module may require additional protection to be installed and may include the detection of: <ul style="list-style-type: none"> <li>• Neutral Voltage Displacement (NVD);</li> <li>• Over Current;</li> <li>• Earth Fault;</li> <li>• Reverse Power.</li> </ul>		P
10.5.2	Neutral Voltage Displacement (NVD) Protection		N/A
10.6	Protection Settings		P
10.6.1	The following notes aim to explain the settings requirements as given in Section 10.6.7 below.		P

G99/1-6			
Clause	Requirement - Test	Result - Remark	Verdict
10.6.2	<p>Loss of Mains</p> <p>A LoM protection of the RoCoF type will generally be appropriate for Type A, Type B and Type C Power Generating Modules, but this type of LoM protection must not be installed for Power Generating Facilities at or above 50 MW. In those cases where the DNO requires LoM protection this must be provided by a means not susceptible to spurious or nuisance tripping, eg intertripping.</p>	See appended table.	P
10.6.3	<p>Under Voltage</p> <p>In order to help maintain Total System Stability, the protection settings aim to facilitate transmission fault ride through capability (as required in Sections 12.3 and 13.3 below). The overall aim is to ensure that Power Generating Module is not disconnected from the Distribution Network unless there is material disturbance on the Distribution Network, as disconnecting generation unnecessarily will tend to make an under voltage situation worse. To maximize the transmission fault ride through capability a single undervoltage setting of - 20% with a time delay of 2.5 s should be applied.</p>	See appended table.	P
10.6.4	<p>Over Voltage</p> <p>Over voltages are potentially more dangerous than under voltages and hence the acceptable excursions from the norm are smaller and time delays shorter, a 2-Stage over voltage protection<sup>6</sup> is to be applied as follows:</p> <ul style="list-style-type: none"> <li>• Stage 1 (LV) should have a setting of +14% (ie the LV statutory upper voltage limit of +10%, with a further 4% permitted for voltage rise internal to the Generator's Installation and measurement errors ), with a time delay of 1.0 s (to avoid nuisance tripping for short duration excursions);</li> <li>• Stage 2 (LV) should have a setting of +19% with a time delay of 0.5 s (ie recognising the need to disconnect quickly for a material excursion);</li> </ul>	See appended table.	P
	<p>Stage 1 (HV) should have a setting of +10% with a time delay of 1.0 s (ie the HV statutory upper voltage limit of +6%, with a further 4% permitted for voltage rise internal to the Generator's Installation and measurement errors), with a time delay of 1.0 s to avoid nuisance tripping for short duration excursions);</p> <p>Stage 2 (HV) should have a setting of +13% with a time delay of 0.5 s (ie recognising the need to disconnect quickly for a material excursion).</p>		N/A

G99/1-6			
Clause	Requirement - Test	Result - Remark	Verdict
	To achieve high utilisation and Distribution Network efficiency, it is common for the HV Distribution Network to be normally operated near to the upper statutory voltage limits. The presence of Power Generating Module within such Distribution Network may increase the risk of the statutory limit being exceeded, eg when the Distribution Network is operating abnormally. In such cases the DNO may specify additional over voltage protection at the Power Generating Module Connection Point. This protection will typically have an operating time delay long enough to permit the correction of transient over voltages by automatic tap-changers.		N/A
10.6.5	<p>Over Frequency</p> <p>Power Generating Modules are required to stay connected to the Total System for frequencies up to 52 Hz for up to 15 minutes so as to provide the necessary regulation to control the Total System frequency to a satisfactory level. In order to prevent the unnecessary disconnection of a large volume of smaller Power Generating Module for all LV and HV connected Power Generating Module a single stage protection is to be applied that has a time delay of 0.5 s and a setting of 52 Hz. If the frequency rises to or above 52 Hz as the result of an undetected islanding condition, the Power Generating Module will be disconnected with a delay of 0.5 s plus circuit breaker operating time.</p>	See appended table.	P
10.6.6	<p>Under Frequency</p> <p>All Power Generating Facilities are required to maintain connection unless the Total System frequency falls below 47.5 Hz for 20 s or below 47 Hz.</p> <p>For all LV and HV connected Power Generating Module, the following 2-stage under frequency protection should be applied:</p> <ul style="list-style-type: none"> <li>• Stage 1 should have a setting of 47.5 Hz with a time delay of 20 s;</li> <li>• Stage 2 should have a setting of 47.0 Hz with a time delay of 0.5 s;</li> </ul>	See appended table.	P
10.6.7	Protection Settings		P

G99/1-6																																																																									
Clause	Requirement - Test				Result - Remark	Verdict																																																																			
10.6.7.1	<p align="center"><b>Table 10.1 Settings for Long-Term Parallel Operation</b></p> <table border="1"> <thead> <tr> <th rowspan="3">Protection Function</th> <th colspan="4">Type A, Type B and Type C Power Generating Modules</th> <th colspan="2">Type D Power Generating Modules and Power Generating Facilities with a Registered Capacity &gt; 50 MW</th> </tr> <tr> <th colspan="2">LV Protection(1)</th> <th colspan="2">HV Protection(1)</th> <th rowspan="2">Trip Setting</th> <th rowspan="2">Time Delay Setting</th> </tr> <tr> <th>Trip Setting</th> <th>Time Delay Setting</th> <th>Trip Setting</th> <th>Time Delay Setting</th> </tr> </thead> <tbody> <tr> <td>U/V</td> <td><math>V\phi-n^{\dagger} -20\%</math></td> <td>2.5 s*</td> <td><math>V\phi-\phi^{\ddagger} -20\%</math></td> <td>2.5 s*</td> <td><math>V\phi-\phi^{\ddagger} -20\%</math></td> <td>2.5 s*</td> </tr> <tr> <td>O/V st 1</td> <td><math>V\phi-n^{\dagger} + 14\%</math></td> <td>1.0 s</td> <td><math>V\phi-\phi^{\ddagger} + 10\%</math></td> <td>1.0 s</td> <td><math>V\phi-\phi^{\ddagger} + 10\%</math></td> <td>1.0 s</td> </tr> <tr> <td>O/V st 2</td> <td><math>V\phi-n^{\dagger} + 19\%^{\S}</math></td> <td>0.5 s</td> <td><math>V\phi-\phi^{\ddagger} + 13\%</math></td> <td>0.5 s</td> <td></td> <td></td> </tr> <tr> <td>U/F st 1</td> <td>47.5 Hz</td> <td>20 s</td> <td>47.5 Hz</td> <td>20 s</td> <td>47.5 Hz</td> <td>20 s</td> </tr> <tr> <td>U/F st 2</td> <td>47.0 Hz</td> <td>0.5 s</td> <td>47.0 Hz</td> <td>0.5 s</td> <td>47.0 Hz</td> <td>0.5 s</td> </tr> <tr> <td>O/F</td> <td>52.0 Hz</td> <td>0.5 s</td> <td>52.0 Hz</td> <td>0.5 s</td> <td>52.0 Hz</td> <td>0.5 s</td> </tr> <tr> <td>LoM (RoCoF)<sup>‡</sup></td> <td colspan="2">1 Hzs<sup>-1</sup> time delay 0.5 s</td> <td colspan="2">1 Hzs<sup>-1</sup> time delay 0.5 s</td> <td colspan="2">Intertripping expected</td> </tr> </tbody> </table>					Protection Function	Type A, Type B and Type C Power Generating Modules				Type D Power Generating Modules and Power Generating Facilities with a Registered Capacity > 50 MW		LV Protection(1)		HV Protection(1)		Trip Setting	Time Delay Setting	Trip Setting	Time Delay Setting	Trip Setting	Time Delay Setting	U/V	$V\phi-n^{\dagger} -20\%$	2.5 s*	$V\phi-\phi^{\ddagger} -20\%$	2.5 s*	$V\phi-\phi^{\ddagger} -20\%$	2.5 s*	O/V st 1	$V\phi-n^{\dagger} + 14\%$	1.0 s	$V\phi-\phi^{\ddagger} + 10\%$	1.0 s	$V\phi-\phi^{\ddagger} + 10\%$	1.0 s	O/V st 2	$V\phi-n^{\dagger} + 19\%^{\S}$	0.5 s	$V\phi-\phi^{\ddagger} + 13\%$	0.5 s			U/F st 1	47.5 Hz	20 s	47.5 Hz	20 s	47.5 Hz	20 s	U/F st 2	47.0 Hz	0.5 s	47.0 Hz	0.5 s	47.0 Hz	0.5 s	O/F	52.0 Hz	0.5 s	52.0 Hz	0.5 s	52.0 Hz	0.5 s	LoM (RoCoF) <sup>‡</sup>	1 Hzs <sup>-1</sup> time delay 0.5 s		1 Hzs <sup>-1</sup> time delay 0.5 s		Intertripping expected			P
Protection Function	Type A, Type B and Type C Power Generating Modules				Type D Power Generating Modules and Power Generating Facilities with a Registered Capacity > 50 MW																																																																				
	LV Protection(1)		HV Protection(1)		Trip Setting		Time Delay Setting																																																																		
	Trip Setting	Time Delay Setting	Trip Setting	Time Delay Setting																																																																					
U/V	$V\phi-n^{\dagger} -20\%$	2.5 s*	$V\phi-\phi^{\ddagger} -20\%$	2.5 s*	$V\phi-\phi^{\ddagger} -20\%$	2.5 s*																																																																			
O/V st 1	$V\phi-n^{\dagger} + 14\%$	1.0 s	$V\phi-\phi^{\ddagger} + 10\%$	1.0 s	$V\phi-\phi^{\ddagger} + 10\%$	1.0 s																																																																			
O/V st 2	$V\phi-n^{\dagger} + 19\%^{\S}$	0.5 s	$V\phi-\phi^{\ddagger} + 13\%$	0.5 s																																																																					
U/F st 1	47.5 Hz	20 s	47.5 Hz	20 s	47.5 Hz	20 s																																																																			
U/F st 2	47.0 Hz	0.5 s	47.0 Hz	0.5 s	47.0 Hz	0.5 s																																																																			
O/F	52.0 Hz	0.5 s	52.0 Hz	0.5 s	52.0 Hz	0.5 s																																																																			
LoM (RoCoF) <sup>‡</sup>	1 Hzs <sup>-1</sup> time delay 0.5 s		1 Hzs <sup>-1</sup> time delay 0.5 s		Intertripping expected																																																																				
	<p>(1) HV and LV Protection settings are to be applied according to the voltage at which the voltage related protection reference is measuring, eg:</p> <ul style="list-style-type: none"> <li>• If the EREC G99 protection takes its voltage reference from an LV source then LV settings shall be applied. Where a private non standard LV network exists the settings shall be calculated from HV settings values as indicated by Section 10.6.14;</li> <li>• If the EREC G99 protection takes its voltage reference from an HV source then HV settings shall be applied.</li> </ul> <p>†A value of 230 V shall be used in all cases for Power Generating Facilities connected to a DNO's LV Distribution Network ie the U/V LV trip setting is 184 V, the O/V stage 1 setting is 262.2 V and the O/V stage 2 setting is 273.7 V.</p> <p>‡A value to suit the nominal voltage of the HV Connection Point.</p> <p>* Might need to be reduced if auto-reclose times are &lt;3 s. (see 10.2.1).</p> <p># Intertripping may be considered as an alternative to the use of a LoM relay.</p> <p>\$ For voltages greater than 230 V +19% which are present for periods of &lt;0.5 s the Power Generating Module is permitted to reduce/cease exporting in order to protect the Power Generating Module.</p>						P																																																																		

G99/1-6																																						
Clause	Requirement - Test			Result - Remark	Verdict																																	
	The required RoCoF protection requirement is expressed in Hertz per second ( $\text{Hzs}^{-1}$ ). The time delay should begin when the measured RoCoF exceeds the threshold expressed in $\text{Hzs}^{-1}$ . The time delay should be reset if measured RoCoF falls below that threshold. The relay must not trip unless the measured rate remains above the threshold expressed in $\text{Hzs}^{-1}$ continuously for 500 ms. Setting the number of cycles on the relay used to calculate the RoCoF is not an acceptable implementation of the time delay since the relay would trip in less than 500 ms if the system RoCoF was significantly higher than the threshold.				P																																	
	(2) Note that the times in the table are the time delays to be set on the appropriate relays. Total protection operating time from condition detection to circuit breaker opening will be of the order of 100 ms longer than the time delay settings in the above table with most circuit breakers, slower operation is acceptable in some cases.				P																																	
	The Manufacturer must ensure that the Interface Protection in a Type Tested Power Generating Module is capable of measuring voltage to an accuracy of $\pm 1.5\%$ of the nominal value and of measuring frequency to $\pm 0.2\%$ of the nominal value across its operating range of voltage, frequency and temperature.				P																																	
10.6.7.2	<p><b>Table 10.2 – Settings for Infrequent Short-Term Parallel Operation</b></p> <table border="1"> <thead> <tr> <th rowspan="3">Protection Function</th> <th colspan="4">Type A, Type B and Type C Power Generating Module</th> </tr> <tr> <th colspan="2">LV Protection</th> <th colspan="2">HV Protection</th> </tr> <tr> <th>Trip Setting</th> <th>Time Delay Setting</th> <th>Trip Setting</th> <th>Time Delay Setting</th> </tr> </thead> <tbody> <tr> <td>U/V</td> <td><math>V\phi-n^{\dagger} -10\%</math></td> <td>0.5 s</td> <td><math>V\phi-\phi^{\ddagger} -6\%</math></td> <td>0.5 s</td> </tr> <tr> <td>O/V</td> <td><math>V\phi-n^{\dagger} + 14\%</math></td> <td>0.5 s</td> <td><math>V\phi-\phi^{\ddagger} + 6\%</math></td> <td>0.5 s</td> </tr> <tr> <td>U/F</td> <td>49.5 Hz</td> <td>0.5 s</td> <td>49.5 Hz</td> <td>0.5 s</td> </tr> <tr> <td>O/F</td> <td>50.5 Hz</td> <td>0.5 s</td> <td>50.5 Hz</td> <td>0.5 s</td> </tr> </tbody> </table> <p><math>\dagger</math>A value of 230 V shall be used in all cases for Power Generating Facilities connected to a DNO's LV Distribution Network (ie the U/V LV trip setting is 207 V and the O/V trip setting is 262.2 V).</p> <p><math>\ddagger</math>A value to suit the voltage of the HV Connection Point.</p>			Protection Function	Type A, Type B and Type C Power Generating Module				LV Protection		HV Protection		Trip Setting	Time Delay Setting	Trip Setting	Time Delay Setting	U/V	$V\phi-n^{\dagger} -10\%$	0.5 s	$V\phi-\phi^{\ddagger} -6\%$	0.5 s	O/V	$V\phi-n^{\dagger} + 14\%$	0.5 s	$V\phi-\phi^{\ddagger} + 6\%$	0.5 s	U/F	49.5 Hz	0.5 s	49.5 Hz	0.5 s	O/F	50.5 Hz	0.5 s	50.5 Hz	0.5 s	Long-Term Parallel Operation.	N/A
Protection Function	Type A, Type B and Type C Power Generating Module																																					
	LV Protection		HV Protection																																			
	Trip Setting	Time Delay Setting	Trip Setting	Time Delay Setting																																		
U/V	$V\phi-n^{\dagger} -10\%$	0.5 s	$V\phi-\phi^{\ddagger} -6\%$	0.5 s																																		
O/V	$V\phi-n^{\dagger} + 14\%$	0.5 s	$V\phi-\phi^{\ddagger} + 6\%$	0.5 s																																		
U/F	49.5 Hz	0.5 s	49.5 Hz	0.5 s																																		
O/F	50.5 Hz	0.5 s	50.5 Hz	0.5 s																																		
10.6.8	Over and Under voltage protection must operate independently for all three phases in all cases.				N/A																																	
10.6.9	The settings in Table 10.1 should generally be applied to all Power Generating Modules. In exceptional circumstances Generators have the option to agree alternative settings with the DNO if there are valid justifications in that the Power Generating Module may become unstable or suffer damage with the settings specified in Table 10.1. The agreed settings should be recorded in the Connection Agreement.				P																																	

G99/1-6			
Clause	Requirement - Test	Result - Remark	Verdict
10.6.10	Once the settings of relays have been agreed between the Generator and the DNO they must not be altered without the written agreement of the DNO. Any revised settings should be recorded again in the amended Connection Agreement.		P
10.6.11	The under/over voltage and frequency protection may be duplicated to protect the Power Generating Module when operating in island mode although different settings may be required.		P
10.6.12	For LV connected Power Generating Modules the voltage settings will be based on the 230 V nominal system voltage. In some cases Power Generating Modules may be connected to LV systems with non-standard operating voltages. Paragraph 10.6.14 details how suitable settings can be calculated based upon the HV connected settings in Table 10.1. Note that Power Generating Modules with non-standard LV protection settings need to be agreed by the DNO on a case by case basis.		P
10.6.13	Where an installation contains Power Factor correction equipment which has a variable susceptance controlled to meet the Reactive Power demands, the probability of sustained generation is increased. For LV installations, additional protective equipment provided by the Generator, is required as in the case of self-excited asynchronous machines.	No such equipment used.	N/A
10.6.14	Non-Standard private LV networks calculation of appropriate protection settings		N/A
10.6.15	The Generator shall provide a means of displaying the protection settings so that they can be inspected if required by the DNO to confirm that the correct settings have been applied. The Manufacturer needs to establish a secure way of displaying the settings in one of the following ways:  (a) A display on a screen which can be read;  (b) A display on an electronic device which can communicate with the Power Generating Module and confirm that it is the correct device by means of a Identification number / name permanently fixed to the device and visible on the electronic device screen at the same time as the settings;  (c) Display of all settings including nominal voltage and current outputs, alongside the identification number / name of the device, permanently fixed to the Power Generating Module.		P

G99/1-6			
Clause	Requirement - Test	Result - Remark	Verdict
	<p>The provision of loose documents, documents attached by cable ties etc., a statement that the device conforms with a standard, or provision of data on adhesive paper based products which are not likely to survive due to fading, or failure of the adhesive, for at least 20 years is not acceptable.</p> <p>The protection arrangements (including changes to protection arrangements) for individual schemes will be agreed between the Generator and the DNO in accordance with this document.</p>		P
10.6.16	Whilst the protection schemes and settings for internal electrical faults should mitigate any damage to the Power Generating Module they must not jeopardise the performance of a Power Generating Module, in line with the requirements set out in this EREC.		P
10.6.17	<p>The Generator shall organise its protection and control devices in accordance with the following priority ranking (from highest to lowest) for Type B, Type C and Type D Power Generating Modules:</p> <p>(a) network and Power Generating Module protection;</p> <p>(b) synthetic inertia, if applicable;</p> <p>(c) frequency control (Active Power adjustment -if any);</p> <p>(d) power restriction (if any); and</p> <p>(e) power gradient constraint (if any).</p>	Type A Power Generating Module.	N/A
10.6.18	For the avoidance of doubt where an internal fault on the Power Generating Module occurs during any significant event on the Total System, the Power Generating Module's internal protection should trip the module to ensure safety and minimise damage to the Power Generating Module.		P
10.7	Typical Protection Application Diagrams		Info.
10.7.1	This Section provides some typical protection application diagrams in relation to parallel operation of Power Generating Modules within DNO Distribution Networks. The diagrams only relate to DNO requirements in respect of the connection to the Distribution Network and do not necessarily cover the safety of the Generator's Installation. The diagrams are intended to illustrate typical installations.		Info.
11	Type A Power Generating Module Technical Requirements		P
11.1	Power Generating Module Performance and Control Requirements – General		P



G99/1-6			
Clause	Requirement - Test	Result - Remark	Verdict
11.1.1	The requirements of this Section 11 do not apply in full to Power Generation Facilities that are designed and installed for infrequent short term parallel operation only nor to storage Power Generation Modules within the Power Generating Facility – refer to Annex A.4.		Info.
11.1.2	The Active Power output of a Power Generating Module should not be affected by voltage changes within the statutory limits declared by the DNO in accordance with the ESQCR.		P
11.1.3	Power Generating Modules connected to the DNO's Distribution Network shall be equipped with a logic interface (input port) in order to cease Active Power output within 5 s following an instruction being received at the input port.		P
11.1.3.1	By default the DNO logic interface will take the form of a simple binary output that can be operated by a simple switch or contactor. When the switch is closed the Power Generating Module can operate normally. When the switch is opened the Power Generating Module will reduce its Active Power to zero within 5 s. The signal from the Power Generating Module that is being switched can be either AC (maximum value 240 V) or DC (maximum value 110 V). If the DNO wishes to make use of the facility to cease Active Power output the DNO will agree with the Generator how the communication path is to be achieved.		P
11.1.4	Each item of a Power Generating Module and its associated control equipment must be designed for stable operation in parallel with the Distribution Network.		P
11.1.5	When operating at rated power the Power Generating Module shall be capable of operating at a Power Factor within the range 0.95 lagging to 0.95 leading relative to the voltage waveform unless otherwise agreed with the DNO.		P
11.1.6	As part of the connection application process the Generator shall agree with the DNO the set points of the control scheme for voltage control, Power Factor control or Reactive Power control as appropriate. These settings, and any changes to these settings, shall be agreed with the DNO and recorded in the Connection Agreement. The information to be provided is detailed in Schedule 5a and Schedule 5b of the Data Registration Code.		P

G99/1-6			
Clause	Requirement - Test	Result - Remark	Verdict
11.1.7	Load flow and System Stability studies may be necessary to determine any output constraints or post fault actions necessary for n-1 fault conditions and credible n-2 conditions (where n-1 and n-2 conditions are the first and second outage conditions as, for example, specified in EREC P2) involving a mixture of fault and planned outages. The Connection Agreement should include details of the relevant outage conditions. It may be necessary under these fault conditions, where the combination of Power Generating Module output, load and through flow levels leads to circuit overloading, to rapidly disconnect or constrain the Power Generating Module.		P
11.2	Frequency response		P
11.2.1	Under abnormal conditions automatic low-frequency load-shedding provides for load reduction down to 47 Hz. In exceptional circumstances, the frequency of the DNO's Distribution Network could rise above 50.5 Hz. Therefore all Power Generating Modules should be capable of continuing to operate in parallel with the Distribution Network in accordance with the following:		P
	(a) 47 Hz – 47.5 Hz Operation for a period of at least 20 s is required each time the frequency is within this range. (b) 47.5 Hz – 49.0 Hz Operation for a period of at least 90 minutes is required each time the frequency is within this range. (c) 49.0 Hz – 51.0 Hz Continuous operation of the Power Generating Module is required. (d) 51.0 Hz – 51.5 Hz Operation for a period of at least 90 minutes is required each time the frequency is within this range. (e) 51.5 Hz – 52 Hz Operation for a period of at least 15 minutes is required each time the frequency is within this range.	See appended table.	P
11.2.2	With regard to the rate of change of frequency withstand capability, a Power Generating Module shall be capable of staying connected to the Distribution Network and operate at rates of change of frequency up to $1 \text{ Hzs}^{-1}$ as measured over a period of 500 ms unless disconnection was triggered by a rate of change of frequency type loss of mains protection or by the Power Generating Module's own protection system for a co-incident internal fault as detailed in paragraph 10.6.18.		P
11.2.3	Output power with falling frequency		P
11.2.3.1	Each Power Generating Module, must be capable of:		P
	(a) continuously maintaining constant Active Power output for system frequency changes within the range 50.5 to 49.5 Hz; and		P

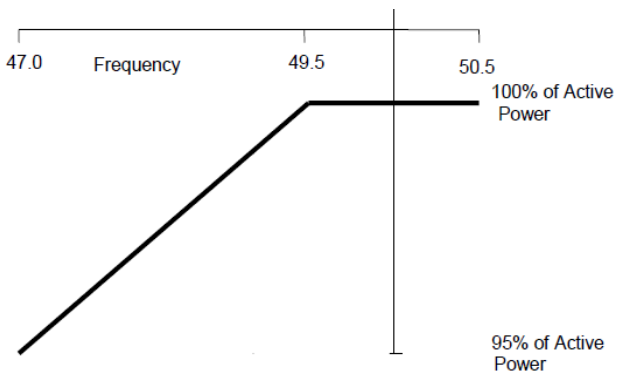
G99/1-6			
Clause	Requirement - Test	Result - Remark	Verdict
	<p>(b) (subject to the provisions of paragraph 11.2.1) maintaining its Active Power output at a level not lower than the figure determined by the linear relationship shown in Figure 11.1 for system frequency changes within the range 49.5 to 47 Hz for all ambient temperatures up to and including 25°C, such that if the system frequency drops to 47 Hz the Active Power output does not decrease by more than 5%.</p>  <p><b>Figure 11.1 Change in Active Power with falling frequency</b></p>		P
11.2.3.2	For the avoidance of doubt in the case of a Power Generating Module using an Intermittent Power Source where the power input will not be constant over time, the requirement is that the Active Power output shall be independent of system frequency under (a) above and should not drop with system frequency by greater than the amount specified in (b) above.		P
11.2.4	Limited Frequency Sensitive Mode – Over frequency		P
11.2.4.1	Each Power Generating Module shall be capable of reducing Active Power output in response to frequency on the Total System when this rises above 50.4 Hz. The Power Generating Module shall be capable of operating stably during LFSM-O operation. If a Power Generating Module has been contracted to operate in Frequency Sensitive Mode the requirements of LFSM-O shall apply when frequency exceeds 50.5 Hz.		P
	(a) The rate of change of Active Power output must be at a minimum a rate of 2% of output per 0.1 Hz deviation of system frequency above 50.4 Hz (ie a Droop of 10%) as shown in Figure 11.2. For the avoidance of doubt, this would not preclude a Generator from designing their Power Generating Module with a Droop of less than 10%, but in all cases the Droop should be 2% or greater.	See appended table.	P
	(b) The Power Generating Module shall be capable of initiating a power frequency response with an initial delay that is as short as possible. If the initial delay exceeds 2 s the Generator shall justify the delay, providing technical evidence to the DNO, who will pass this evidence to the NETSO.		P

G99/1-6			
Clause	Requirement - Test	Result - Remark	Verdict
	(c) For deviations in frequency up to 50.9Hz at least half of the proportional reduction in Active Power output shall be achieved within 10 s of the time of the frequency increase above 50.4 Hz.		P
	(d) For deviations in frequency beyond 50.9 Hz the measured rate of change of Active Power reduction shall exceed 0.5% s-1 of the initial output.		P
	(e) The LFMS-O response shall be reduced when the frequency subsequently falls again and, when to a value less than 50.4 Hz, at least half the proportional increase in Active Power shall be achieved in 10 s. For a frequency excursion returning from beyond 50.9 Hz the measured rate of change Active Power increase shall exceed 0.5% s-1.		P
	(f) If the reduction in Active Power is such that the Power Generation Module reaches its Minimum Stable Operating Level, it shall continue to operate stably at this level.		P
	<p><b>Figure 11.2 Active Power Frequency Response capability when operating in LFMS-O</b></p>		P
11.2.4.2	When the Power Generating Module is providing Limited Frequency Sensitive Mode Over frequency (LFMS-O) response it must continue to provide the frequency response until the frequency has returned to, or is below, 50.4 Hz.		P
11.2.4.3	Steady state operation below Minimum Generation is not expected but if system operating conditions cause operation below Minimum Generation which give rise to operational difficulties then the Generator shall be able to return the output of the Power Generating Module to an output of not less than the Minimum Generation.		P
11.3	Fault Ride Through and Phase Voltage Unbalance		N/A

G99/1-6			
Clause	Requirement - Test	Result - Remark	Verdict
11.3.1	Where it has been specifically agreed between the DNO and the Generator that a Power Generating Facility will contribute to the DNO's Distribution Network security, (eg for compliance with EREC P2) the Power Generating Module(s) may be required to withstand, without tripping, the effects of a close up three phase fault and the Phase (Voltage) Unbalance imposed during the clearance of a close-up phase-to-phase fault, in both cases cleared by the DNO's main protection. The DNO will advise the Generator in each case of the likely tripping time of the DNO's protection, and for phase-phase faults, the likely value of Phase (Voltage) Unbalance during the fault clearance time.	Single phase Power Generating Module.	N/A
11.3.2	In the case of phase to phase faults on the DNO's system that are cleared by system back-up protection which will be within the plant short time rating on the DNO's Distribution Network the DNO, on request during the connection process, will advise the Generator of the expected Phase (Voltage) Unbalance.		N/A
11.4	Voltage Limits and Control		P
11.4.1	Where a Power Generating Module is remote from a Network voltage control point it may be required to withstand voltages outside the normal statutory limits. In these circumstances, the DNO should agree with the Generator the declared voltage and voltage range at the Connection Point. Immunity of the Power Generating Module to voltage changes of $\pm 10\%$ of the declared voltage is recommended, subject to design appraisal of individual installations.		P
11.4.2	The connection of a Power Generating Module to the Distribution Network shall be designed in such a way that operation of the Power Generating Module does not adversely affect the voltage profile of and voltage control employed on the Distribution Network. ETR 126 provides DNOs with guidance on active management solutions to overcome voltage control limitations. Information on the voltage regulation and control arrangements will be made available by the DNO if requested by the Generator.		P
11.4.3	The final responsibility for control of Distribution Network voltage does however remain with the DNO.		P
11.4.4	Automatic Voltage Control (AVC) schemes employed by the DNO often assume that power flows from parts of the Distribution Network operating at a higher voltage to parts of the Distribution Network operating at lower voltages.		P

G99/1-6			
Clause	Requirement - Test	Result - Remark	Verdict
11.4.5	Power Generating Modules can cause problems if connected to networks employing AVC schemes which use negative reactance compounding and line drop compensation due to changes in Active Power and Reactive Power flows. ETR 126 provides guidance on connecting generation to such networks using techniques such as removing the generation circuit from the AVC scheme using cancellation CTs.		P
12	Type B Power Generating Module Technical Requirements	Type A Power Generating Module.	N/A
12.1	Power Generating Module Performance and Control Requirements - General		N/A
12.2	Frequency response		N/A
12.3	Fault Ride Through and Phase Voltage Unbalance		N/A
12.4	Voltage Limits and Control		N/A
12.5	Reactive Capability		N/A
12.6	Fast Fault Current Injection		N/A
12.7	Operational monitoring		N/A
13	Type C and Type D Power Generating Module Technical Requirements	Type A Power Generating Module.	N/A
13.1	Power Generating Module Performance and Control Requirements		N/A
13.2	Frequency response		N/A
13.3	Fault Ride Through		N/A
13.4	Voltage Limits and Control		N/A
13.5	Fast Fault Current Injection		N/A
13.6	Black Start Capability		N/A
13.7	Technical Requirements for Embedded Medium Power Stations		N/A
13.8	Operational monitoring		N/A
13.9	Steady State Load Inaccuracies		N/A
14	Installation, Operation and Control Interface		P
14.1	General		P
14.2	Isolation and Safety Labelling		P
14.2.1	Every Generator's Installation which includes Power Generating Modules operating in parallel with the Distribution Network must include a means of isolation capable of disconnecting the whole of the Power Generating Module7 infeed to the Distribution Network. This equipment will normally be owned by the Generator, but may by agreement be owned by the DNO.		P

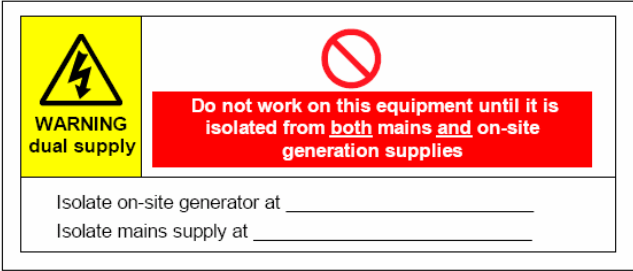
G99/1-6			
Clause	Requirement - Test	Result - Remark	Verdict
14.2.2	The Generator must grant the DNO rights of access to the means of isolation without undue delay and the DNO must have the right to isolate the Power Generation Modules infeed at any time should such disconnection become necessary for safety reasons and in order to comply with statutory obligations. The isolating device should normally be installed at the Connection Point, but may be positioned elsewhere with the DNO's agreement.		P
14.2.3	To ensure that DNO staff and that of the Generator and their contractors are aware of the presence of a Power Generating Module, appropriate warning labels should be used.		P
14.2.4	Where the installation is connected to the DNO LV Distribution Network the Generator should generally provide labelling at the Connection Point (Fused Cut-Out), meter position, consumer unit and at all points of isolation within the Generator's premises to indicate the presence of a Power Generating Module. The labelling should be sufficiently robust and if necessary fixed in place to ensure that it remains legible and secure for the lifetime of the installation. The Health and Safety (Safety Signs & Signals) Regulations 1996 stipulates that labels should display the prescribed triangular shape, and size, using black on yellow colouring. A typical label, for both size and content, is shown below in Figure 14.1.  		P
14.3	Site Responsibility Schedule		Info.
14.4	Operational and Safety Aspects		Info.
14.5	Synchronizing and Operational Control		P
15	Common Compliance and Commissioning Requirements for all Power Generating Modules	It's depended on installer and DNOs.	N/A
15.1	Demonstration of Compliance		N/A
15.2	Wiring for Type Tested Power Generating Modules		N/A
15.3	Commissioning Tests / Checks required at all Power Generating Facilities		N/A
15.4	Additional Commissioning requirements for Non Type Tested Interface Protection		N/A
16	Type A Compliance Testing, Commissioning and Operational Notification		P

G99/1-6			
Clause	Requirement - Test	Result - Remark	Verdict
16.1	Type Test Certification		P
16.1.1	The Power Generating Module can comprise Fully Type Tested equipment or be made up of some Type Tested equipment and require additional site testing prior to operation. The use of Fully Type Tested equipment simplifies the connection process, the protection arrangements and reduces the commissioning test requirements.		P
16.1.2	Type Tested certification is the responsibility of the Manufacturer. The Manufacturer shall submit the Type Test Verification Report confirming that the product has been Type Tested to satisfy the requirements of this EREC G99 to the Energy Networks Association (ENA) Type Test Verification Report Register. The report shall detail the type and model of product tested, the test conditions and results recorded. The report can include reference to Manufacturers' Information.		P
16.1.3	The required Type Test Verification Report and declarations including that for a Fully Type Tested Power Generating Module are shown in Annex A.2:		P
	• Form A2-1 - Compliance Verification Report for Synchronous Power Generating Modules up to and including 50 kW,	Inverter Connected Power Generating Modules.	N/A
	• Form A2-2 Compliance Verification Report for Synchronous Power Generating Modules greater than > 50 kW and also for Synchronous Power Generating Modules ≤ 50 kW where the approach of this form is preferred to that in Form A2-1, or	Inverter Connected Power Generating Modules.	N/A
	• Form A2-3 - Compliance Verification Report for Inverter Connected Power Generating Modules.		P



G99/1-6			
Clause	Requirement - Test	Result - Remark	Verdict
	<p>The choice of compliance route available is shown in Figure 16-1 below.</p> <p>Figure 16-1 Illustration of the choice of compliance route</p>	Compliance Verification Report A2-3 used.	P
	It is intended that the Manufacturers will use the requirements of this EREC G99 to develop type verification certification (ie the Compliance Verification Report as shown in Annex A.2) for each of their Power Generating Module models.		P
	Form A2-3 caters for all asynchronous and inverter technologies of any size, with the exception of conventional induction Generating Units. Manufacturers of induction Generating Units may find it more appropriate to use forms A2-2 or A2-1 in preference to A2-3.		P
16.1.4	Guidance for Manufacturers on type testing for Power Generating Modules is included in Annex A.7 of this document.		P
16.1.5	Compliance with the requirements detailed in this EREC G99 will ensure that the Power Generating Module is considered to be approved for connection to the DNO's Distribution Network.		P
16.1.6	The Power Generating Module shall comply with all relevant UK and European Directives and should be labelled in accordance with those requirements.		P

G99/1-6			
Clause	Requirement - Test	Result - Remark	Verdict
16.2	Connection Process	Relied on installer	P
	16.2.1 The Installer shall discuss the installation project with the local DNO at the earliest opportunity. The connection application will need to be in format as shown in Annex A.1 (Form A1) or for Power Generating Modules greater than 50 kW by using the Standard Application Form (generally available from the DNOs website). Where a Power Generating Module is Fully Type Tested and registered with the Energy Networks Association Type Test Verification Report Register, the application should include the Manufacturer's reference number (the Product ID), and the compliance test results do not need to be submitted as part of the application.		P
16.2.2	Where a Power Generating Module is not Fully Type Tested, the Generator or Installer shall provide the DNO with a Compliance Verification Report as per Annex A.2 (Forms A2-1, A2-2 or A2-3 as applicable) confirming that the Power Generating Module has or will be tested to satisfy the requirements of this EREC G99. On receipt of the application, the DNO will assess: <ul style="list-style-type: none"> <li>• whether any Distribution Network studies are required;</li> <li>• whether there is a need for work on the Distribution Network before the Tested Power Generating Module can be connected to the Distribution Network; and</li> <li>• whether there is a requirement to witness the commissioning tests and checks.</li> </ul>	Fully Type Test.	N/A
16.2.3	Connection of the Power Generating Module is only allowed after the application for connection has been approved by the DNO and any DNO works facilitating the connection have been completed.	It's depended on installer and DNOs.	N/A
16.2.4	Where Power Generating Modules require connection to the DNO's Distribution Network in advance of the commissioning date, for the purposes of testing, the Power Generating Facility must comply with the requirements of the Connection Agreement. The Generator shall provide the DNO with a commissioning programme, which will be approved by the DNO if reasonable in the circumstances, to allow commissioning tests to be co-ordinated.	It's depended on installer and DNOs.	N/A

G99/1-6			
Clause	Requirement - Test	Result - Remark	Verdict
16.2.5	Where commissioning tests are not witnessed, confirmation of the commissioning of each Power Generating Module will need to be made no later than 28 days after commissioning; the format and content shall be as shown in Annex A.3 (Form A3) Installation Document. The Installer or Generator, as appropriate, shall complete the declaration at the bottom of the Installation Document (Form A3) noting that this declaration also covers the Site Compliance and Commissioning Test Form (Form A2-4). Where the tests are witnessed a copy shall be provided to the DNO at the time of commissioning.	It's depended on installer and DNOs.	N/A
16.2.6	It is the responsibility of the Generator (which may be delegated to the Installer) to ensure that the relevant information is forwarded to the local DNO. The pro forma in Annex A are designed to: (a) simplify the connection procedure for both DNO and Installer; (b) provide the DNO with all the information required to assess the potential impact of the Power Generating Module connection on the operation of the Distribution Network; (c) inform the DNO that the Generator's Installation complies with the requirements of this EREC G99; (d) allow the DNO to accurately record the location of all Power Generating Modules connected to the Distribution Network.	It's depended on installer and DNOs.	N/A
16.3	Witnessing and Commissioning	It's depended on installer and DNOs.	N/A
16.4	Operational Notification		N/A
16.4.1	Notification that the Power Generating Module has been connected / commissioned is achieved by completing an Installation Document as per Annex A.3, which also includes the relevant details on the Generator's Installation required by the DNO.		N/A
16.4.2	The Installer, or an agent acting on behalf of the Installer, shall supply separate Installation Documents (Annex A.3, Form A3) for each Power Generating Facility installed under EREC G99 to the DNO. Documentation shall be supplied either at the time of commissioning (where tests are witnessed) or within 28 days of the commissioning date (where the tests are not witnessed) and may be submitted electronically.	It's depended on installer and DNOs.	N/A
17	Type B Compliance Testing, Commissioning and Operational Notification	Type A Power Generating Module.	N/A
17.1	General		N/A
17.2	Connection Process		N/A
17.3	Witnessing and Commissioning		N/A

G99/1-6			
Clause	Requirement - Test	Result - Remark	Verdict
17.4	Operational Notification		N/A
18	Type C Compliance Testing, Commissioning and Operational Notification	Type A Power Generating Module.	N/A
18.1	General		N/A
18.2	Connection Process		N/A
18.3	Witnessing and Commissioning		N/A
18.4	Operational Notification		N/A
19	Type D Compliance Testing, Commissioning and Operational Notification	Type A Power Generating Module.	N/A
19.1	General		N/A
19.2	Connection Process		N/A
19.3	Interim Operational Notification		N/A
19.4	Final Operational Notification		N/A
19.5	Limited Operational Notification		N/A
19.6	Processes Relating to Derogations		N/A
20	Ongoing Obligations		N/A
20.1	Periodic Testing for Power Generating Modules		N/A
20.2	Operational Incidents affecting Compliance of any Power Generating Module		N/A
20.3	Changes to the Power Generating Facility or Power Generating Module		N/A
20.4	Notification of Decommissioning		N/A
21	Manufacturers' Information applicable to Power Park Modules		P
21.1	General		P
21.1.1	Data and performance characteristics in respect of EREC G99 requirements may be registered with the DNO by Generating Unit Manufacturers in respect of specific models of Generating Units by submitting information in the form of Manufacturers' Information to the DNO.		P
21.1.2	Manufacturers' Information covers such information as type testing details, parameters or data, simulation models and reports on studies run using those models. For the purpose of this Section 21 Manufacturers' Information will generally relate to simulation models.		P

G99/1-6			
Clause	Requirement - Test	Result - Remark	Verdict
21.1.3	A Generator planning to construct a new Power Generating Facility containing the appropriate version of Generating Units in respect of which Manufacturers' Information has been submitted to the DNO may reference the Manufacturers' Information in its submissions to the DNO. Any Generator considering referring to Manufacturers' Information for any aspect of its plant and apparatus may contact the DNO to discuss the suitability of the relevant Manufacturers' Information to its project to determine if, and to what extent, the data included in the Manufacturers' Information contributes towards demonstrating compliance with those aspects of this EREC G99 applicable to the Generator. The DNO will inform the Generator if the reference to the Manufacturers' Information is not appropriate or not sufficient for its project.		P
21.1.4	The process to be followed by Generating Unit Manufacturers submitting Manufacturers' Information must be agreed by the DNO. Paragraph 21.2 below indicates the specific requirement areas in respect of which Manufacturers' Information may be submitted.		P
21.1.5	The DNO may maintain and publish a register of that Manufacturers' Information which the DNO has received and accepted as being an accurate representation of the performance of the relevant plant and / or apparatus. Such register will clearly identify the Manufacturer, the model(s) of Generating Unit(s) to which the report applies and the provisions of EREC G99 in respect of which the report contributes towards the demonstration of compliance in such a way that these models can easily be identified for appropriate use in other similar projects. The inclusion of any report in the register does not in any way confirm that any Power Park Modules which utilise any Generating Unit(s) covered by a report is or will be compliant with EREC G99.	It's depended on installer and DNOs.	N/A
21.2	Manufacturers' Information in respect of Generating Units may cover one (or part of one) or more of the following provisions: (a) Fault Ride Through capability; (b) Power Park Module mathematical model DDRC 5c.		P

G99/1-6			
Clause	Requirement - Test	Result - Remark	Verdict
21.3	<p>Reference to a Manufacturer's Data &amp; Performance Report in a Generator's submissions does not by itself constitute compliance with EREC G99.</p> <p>A Generator referencing Manufacturers' Information should insert the relevant Manufacturers' Information reference in the appropriate place in the submission forms detailed in the Appendices. The DNO will consider the suitability of Manufacturers' Information in place of DDRC data submissions a mathematical model suitable for representation of the entire Power Park Module as per Annex B.4.3.5 or Annex C.7.4.5 as applicable. Site specific parameters will still need to be submitted by the Generator.</p>		P
21.4	<p>It is the responsibility of the Generator to ensure that the correct reference for the Manufacturers' Information is used and the Generator by using that reference accepts responsibility for the accuracy of the information. The Generator shall ensure that the Manufacturer has kept the DNO informed of any relevant variations in plant specification since the submission of the relevant Manufacturers' Information which could affect the validity of the information.</p>		P
21.5	<p>The DNO may contact the Generating Unit Manufacturer directly to verify the relevance of the use of such Manufacturers' Information. If the DNO believes the use some or all of such Manufacturers' Information is incorrect or the referenced data is inappropriate then the reference to the Manufacturers' Information may be declared invalid by the DNO. Where, and to the extent possible, the data included in the Manufacturers' Information is appropriate, the compliance assessment process will be continued using the data included in the Manufacturers' Information.</p>	It's depended on installer and DNOs.	N/A
22	Type Testing and Annex information		P
22.1	Fully Type Tested and Partially Type Tested equipment		P

G99/1-6																						
Clause	Requirement - Test		Result - Remark	Verdict																		
	<p>The following matrix demonstrates where Manufacturers' Information and compliance and installation checks on site can be combined to demonstrate compliance for each Power Generating Module.</p> <table border="1"> <thead> <tr> <th></th> <th>Manufacturers' Information</th> <th>Site Tests</th> </tr> </thead> <tbody> <tr> <td>Fully Type Tested (assumed Type A only)</td> <td>Registered as Fully Type Tested information on ENA website via the Compliance Verification Report (Form A2-1, A2-2 or A2-3 as appropriate)</td> <td>Only installation checks required – as on the Installation Document (Form A3)</td> </tr> <tr> <td>Partially Type Tested (Type A)</td> <td>           (i) Registered as product or component Type Test information on ENA Website using applicable parts of Compliance Verification Report (Form A2-1, A2-2 or A2-3); and/or            (ii) Supplied by the Generator using applicable parts of Compliance Verification Report (Form A2-1, A2-2 or A2-3)         </td> <td>           Demonstration of technical requirements not covered by <b>Manufacturers' Information</b>. (Form A3)             Standard installation checks (Form A3). Additional Site Compliance and Commissioning Checks (Form A2-4) may also be required         </td> </tr> <tr> <td>Partially Type Tested (B, C, D)</td> <td>           (iii) Registered as product or component Type Test information on ENA Website; and/or            (iv) Supplied by the Generator         </td> <td>           Demonstration of technical requirements not covered by <b>Manufacturers' Information</b>. (Form B2-1 or Form C2-1)             Standard installation checks (Form B3 or Form C3).             Additional Site Compliance and Commissioning Checks (Form B2-2 or Form C2-2) may also be required         </td> </tr> <tr> <td>One off installation (B, C, D)</td> <td>To be provided by the Generator for those aspects that cannot be demonstrated on site (including simulations etc)</td> <td>Demonstration of technical requirements not covered by <b>Manufacturers' Information</b>. (Form B2-1 or Form C2-1)</td> </tr> <tr> <td></td> <td></td> <td>Standard installation checks also required (Form B3 or Form C3). Additional Site Compliance and Commissioning Checks (Form B2-2 or Form C2-2) may also be required</td> </tr> </tbody> </table>			Manufacturers' Information	Site Tests	Fully Type Tested (assumed Type A only)	Registered as Fully Type Tested information on ENA website via the Compliance Verification Report (Form A2-1, A2-2 or A2-3 as appropriate)	Only installation checks required – as on the Installation Document (Form A3)	Partially Type Tested (Type A)	(i) Registered as product or component Type Test information on ENA Website using applicable parts of Compliance Verification Report (Form A2-1, A2-2 or A2-3); and/or (ii) Supplied by the Generator using applicable parts of Compliance Verification Report (Form A2-1, A2-2 or A2-3)	Demonstration of technical requirements not covered by <b>Manufacturers' Information</b> . (Form A3)  Standard installation checks (Form A3). Additional Site Compliance and Commissioning Checks (Form A2-4) may also be required	Partially Type Tested (B, C, D)	(iii) Registered as product or component Type Test information on ENA Website; and/or (iv) Supplied by the Generator	Demonstration of technical requirements not covered by <b>Manufacturers' Information</b> . (Form B2-1 or Form C2-1)  Standard installation checks (Form B3 or Form C3).  Additional Site Compliance and Commissioning Checks (Form B2-2 or Form C2-2) may also be required	One off installation (B, C, D)	To be provided by the Generator for those aspects that cannot be demonstrated on site (including simulations etc)	Demonstration of technical requirements not covered by <b>Manufacturers' Information</b> . (Form B2-1 or Form C2-1)			Standard installation checks also required (Form B3 or Form C3). Additional Site Compliance and Commissioning Checks (Form B2-2 or Form C2-2) may also be required	Fully Type Tested.	P
	Manufacturers' Information	Site Tests																				
Fully Type Tested (assumed Type A only)	Registered as Fully Type Tested information on ENA website via the Compliance Verification Report (Form A2-1, A2-2 or A2-3 as appropriate)	Only installation checks required – as on the Installation Document (Form A3)																				
Partially Type Tested (Type A)	(i) Registered as product or component Type Test information on ENA Website using applicable parts of Compliance Verification Report (Form A2-1, A2-2 or A2-3); and/or (ii) Supplied by the Generator using applicable parts of Compliance Verification Report (Form A2-1, A2-2 or A2-3)	Demonstration of technical requirements not covered by <b>Manufacturers' Information</b> . (Form A3)  Standard installation checks (Form A3). Additional Site Compliance and Commissioning Checks (Form A2-4) may also be required																				
Partially Type Tested (B, C, D)	(iii) Registered as product or component Type Test information on ENA Website; and/or (iv) Supplied by the Generator	Demonstration of technical requirements not covered by <b>Manufacturers' Information</b> . (Form B2-1 or Form C2-1)  Standard installation checks (Form B3 or Form C3).  Additional Site Compliance and Commissioning Checks (Form B2-2 or Form C2-2) may also be required																				
One off installation (B, C, D)	To be provided by the Generator for those aspects that cannot be demonstrated on site (including simulations etc)	Demonstration of technical requirements not covered by <b>Manufacturers' Information</b> . (Form B2-1 or Form C2-1)																				
		Standard installation checks also required (Form B3 or Form C3). Additional Site Compliance and Commissioning Checks (Form B2-2 or Form C2-2) may also be required																				
22.2	Annex Contents and Form Guidance			P																		
	<table border="1"> <thead> <tr> <th>Annex</th> <th>Application</th> <th>Form Title</th> </tr> </thead> <tbody> <tr> <td>A.0</td> <td>Cover Sheet for Type A Power Generating Facility Forms</td> <td></td> </tr> <tr> <td>A.1</td> <td>Connection Application for Type A Fully Type Tested (&lt;50 kW) Note for all other Power Generating Modules the DNO's Standard Application Form shall be used.</td> <td>Form A1: Application for connection of Power Generating Module(s) with Total Aggregate Capacity &lt;50 kW 3-phase or 17 kW single phase</td> </tr> </tbody> </table>	Annex	Application	Form Title	A.0	Cover Sheet for Type A Power Generating Facility Forms		A.1	Connection Application for Type A Fully Type Tested (<50 kW) Note for all other Power Generating Modules the DNO's Standard Application Form shall be used.	Form A1: Application for connection of Power Generating Module(s) with Total Aggregate Capacity <50 kW 3-phase or 17 kW single phase		P										
Annex	Application	Form Title																				
A.0	Cover Sheet for Type A Power Generating Facility Forms																					
A.1	Connection Application for Type A Fully Type Tested (<50 kW) Note for all other Power Generating Modules the DNO's Standard Application Form shall be used.	Form A1: Application for connection of Power Generating Module(s) with Total Aggregate Capacity <50 kW 3-phase or 17 kW single phase																				

G99/1-6				
Clause	Requirement - Test		Result - Remark	Verdict
	A.2	Compliance report for <b>Type A Type Tested</b>	<p>Form A2-1: Compliance Verification Report for <b>Synchronous Power Generating Modules</b> up to and including 50 kW</p> <p>Form A2-2: Compliance Verification Report for <b>Synchronous Power Generating Modules &gt; 50 kW</b> and also for <b>Synchronous Power Generating Modules ≤ 50 kW</b> where the approach of this form is preferred to that in Form A2-1</p> <p>Form A2-3 Compliance Verification Report for <b>Inverter Connected Power Generating Modules</b></p>	P
	A.2	Additional Compliance and Commissioning test requirements for <b>Type A Power Generating Modules</b>	Form A2-4: Site Compliance and Commissioning test requirements for <b>Type A Power Generating Modules</b>	
	A.3	Installation and Commissioning a <b>Power Generating Facility</b> comprising one or more <b>Type A Generating Modules</b>	Form A3: Installation Document	
	A.4	Emerging Technologies and other Exceptions		
	A.5	Example calculations to determine if unequal generation across different phases is acceptable or not		
	A.6	Non-Standard private LV networks calculation of appropriate protection settings		
	A.7	Requirements for Type Testing <b>Type A Power Generating Modules</b>		
	B.1	Application	Refer to Standard Application Form	
	B.2-1	Compliance documentation for <b>Type B, Type C</b> and <b>Type D PGFs</b>	Form B2-1: <b>Power Generating Module Document for Type B Power Generating Modules</b>	
	B.2-2	Additional Compliance and Commissioning test requirements for <b>Power Generating Modules</b>	Form B2-2 Site Compliance and Commissioning test requirements for <b>Type B Power Generating Modules</b>	
	B.3	Installation and Commissioning Confirmation Form	Form B2: Installation and Commissioning Confirmation Form for <b>Type B Power Generating Modules</b>	
	B.4	Simulation Studies for <b>Type B Power Generating Modules</b>		
	B.5	Compliance Testing of <b>Type B Synchronous Power Generating Modules</b>		
	B.6	Compliance testing of <b>Type B Power Park Modules</b>		
	C.1	Application	Refer to Standard Application Form	
	C.2-1	<b>Power Generating Module Document for Type C and Type D</b>	Form C2-1: <b>Power Generating Module Document for Type C and Type D Power Generating Modules</b>	
	C.2-2	Additional Compliance and Commissioning test requirements for <b>Power Generating Modules</b>	Form C2-2 Site Compliance and Commissioning test requirements for and <b>Type D Power Generating Modules</b>	



G99/1-6					
Clause	Requirement - Test			Result - Remark	Verdict
	C.3	Installation and Commissioning Confirmation Form	Form C3: Installation and Commissioning Confirmation Form for <b>Type C</b> and <b>Type D Power Generating Modules</b>		P
	C.4	Performance Requirements For Continuously Acting Automatic Excitation Control Systems For <b>Type C</b> and <b>Type D Synchronous Power Generating Modules</b>			
	C.5	Performance Requirements For Continuously Acting			
		Automatic Excitation Control Systems For <b>Type C</b> and <b>Type D Power Park Modules</b>			
	C.6	Functional Specification for Fault Recording and Power Quality Monitoring Equipment Studies for <b>Type C</b> and <b>Type D Power Generating Modules</b>			
	C.7	Simulation Studies for <b>Type C</b> and <b>Type D Power Generating Modules</b>			
	C.8	Compliance Testing of <b>Type C</b> and <b>Type D Synchronous Power Generating Modules</b>			
	C.9	Compliance Testing of <b>Type C</b> and <b>Type D Power Park Modules</b>			
	C.10	Minimum Frequency Response Capabilities for <b>Type C</b> and <b>Type D Power Generating Modules</b>			
	D.1	Decommissioning of any <b>Power Generating Module</b>	Form D1: Decommissioning Confirmation		
	D.2	Additional Information Relating to <b>System Stability</b> Studies			
	D.3	Loss of Mains Protection Analysis			
	D.4	Main Statutory and other Obligations			

G99/1-6			
Clause	Requirement - Test	Result - Remark	Verdict

## Appendix 1: Compliance Verification Report – Tests for Type A Inverter Connected Power Generating Modules – test record

<p><b>1. Operating Range:</b> Four tests should be carried with the <b>Power Generating Module operating at Registered Capacity</b> and connected to a suitable test supply or grid simulation set. The power supplied by the primary source shall be kept stable within <math>\pm 5\%</math> of the apparent power value set for the entire duration of each test sequence.</p> <p>Frequency, voltage and <b>Active Power</b> measurements at the output terminals of the <b>Power Generating Module</b> shall be recorded every second. The tests will verify that the <b>Power Generating Module</b> can operate within the required ranges for the specified period of time.</p> <p>The <b>Interface Protection</b> shall be disabled during the tests.</p>				
Test 1				
Voltage = 85% of nominal (195.5 V), Frequency = 47 Hz, <b>Power Factor</b> = 1, Period of test 20 s				
Test 2				
Voltage = 85% of nominal (195.5 V), Frequency = 47.5 Hz, <b>Power Factor</b> = 1, Period of test 90 minutes				
Test 3				
Voltage = 110% of nominal (253 V), Frequency = 51.5 Hz, <b>Power Factor</b> = 1, Period of test 90 minutes				
Test 4				
Voltage = 110% of nominal (253 V), Frequency = 52.0 Hz, <b>Power Factor</b> = 1, Period of test 15 minutes				
Test 5 RoCoF withstand				
Confirm that the <b>Power Generating Module</b> is capable of staying connected to the <b>Distribution Network</b> and operate at rates of change of frequency up to $1 \text{ Hz s}^{-1}$ as measured over a period of 500 ms. Note that this is not expected to be demonstrated on site.				
Model: AF6K-SL				
Test 1				<b>P</b>
Measured Voltage (V)	Measured Frequency (Hz)	Measured Power (W)	Measured Power factor	Test Time (seconds)
193.21	47.00	6215.0	0.9995	20
Test 2				<b>P</b>

G99/1-6					
Clause	Requirement - Test			Result - Remark	Verdict
Measured Voltage (V)	Measured Frequency (Hz)	Measured Power (W)	Measured Power factor	Test Time (Minutes)	
193.32	47.50	6219.3	0.9995	90	
Test 3					<b>P</b>
Measured Voltage (V)	Measured Frequency (Hz)	Measured Power (W)	Measured Power factor	Test Time (Minutes)	
253.11	51.50	6109.7	0.9995	90	
Test 4					<b>P</b>
Measured Voltage (V)	Measured Frequency (Hz)	Measured Power (W)	Measured Power factor	Test Time (Minutes)	
252.98	52.00	6110.0	0.9996	15	
Test 5					<b>P</b>
Measured Voltage (V)	Ramp range	Test frequency ramp	Test Duration	Confirm no trip	
195.5	47.0 Hz to 52.0 Hz	+1 Hzs <sup>-1</sup>	5.0 s	No trip	
253.0	52.0 Hz to 47.0 Hz	-1 Hzs <sup>-1</sup>	5.0 s	No trip	
Note: The tests were performed on model AF6K-SL also applicable for all other models stated in this report.					

G99/1-6			
Clause	Requirement - Test	Result - Remark	Verdict

<b>2. Power Quality – Harmonics:</b> For <b>Power Generating Modules of Registered Capacity</b> of less than 75 A per phase (ie 50 kW) the test requirements are specified in Annex A.7.1.5. These tests should be carried out as specified in BS EN 61000-3-12 The results need to comply with the limits of Table 2 of BS EN 61000-3-12 for single phase equipment and Table 3 of BS EN 61000-3-12 for three phase equipment. For <b>Power Generating Modules of Registered Capacity</b> of greater than 75 A per phase (ie 50 kW) the installation shall be designed in accordance with EREC G5.						<b>P</b>	
<b>Power Generating Module</b> tested to BS EN 61000-3-12							
Model: AF6K-SL							
<b>Power Generating Module</b> rating per phase (rpp)			6.0	kVA	Harmonic % = Measured Value (A) x 23/rating per phase (kVA)		
Harm onic	At 45-55% of <b>Registered Capacity</b>		100% of <b>Registered Capacity</b>		Limit in BS EN 61000-3-12		
	Measured Value MV in Amps	%	Measured Value MV in Amps	%	1 phase	3 phase	
2	0.093	0.356	0.075	0.289	8%	8%	
3	0.238	0.913	0.202	0.775	21.6%	Not stated	
4	0.014	0.055	0.011	0.044	4%	4%	
5	0.085	0.324	0.100	0.385	10.7%	10.7%	
6	0.017	0.065	0.011	0.043	2.67%	2.67%	
7	0.050	0.192	0.062	0.237	7.2%	7.2%	
8	0.013	0.051	0.012	0.045	2%	2%	
9	0.047	0.181	0.051	0.195	3.8%	Not stated	
10	0.014	0.052	0.011	0.041	1.6%	1.6%	
11	0.019	0.074	0.027	0.102	3.1%	3.1%	
12	0.014	0.055	0.011	0.041	1.33%	1.33%	
13	0.017	0.066	0.019	0.071	2%	2%	
THD	--	1.31	---	1.86	23%	13%	
PWHD	--	1.15	---	1.32	23%	22%	

THD = Total Harmonic Distortion

PWHD = Partial Weighted Harmonic Distortion

G99/1-6			
Clause	Requirement - Test	Result - Remark	Verdict

<p><b>2. Power Quality – Harmonics:</b></p> <p>For <b>Power Generating Modules of Registered Capacity</b> of less than 75 A per phase (ie 50 kW) the test requirements are specified in Annex A.7.1.5. These tests should be carried out as specified in BS EN 61000-3-12 The results need to comply with the limits of Table 2 of BS EN 61000-3-12 for single phase equipment and Table 3 of BS EN 61000-3-12 for three phase equipment.</p> <p>For <b>Power Generating Modules of Registered Capacity</b> of greater than 75 A per phase (ie 50 kW) the installation shall be designed in accordance with EREC G5.</p>						<b>P</b>	
<b>Micro-generator</b> tested to BS EN 61000-3-12							
Model: AF4K-SL							
<b>Power Generating Module</b> rating per phase (rpp)			4.0	kVA	Harmonic % = Measured Value (A) x 23/rating per phase (kVA)		
Harmonic	At 45-55% of <b>Registered Capacity</b>		100% of <b>Registered Capacity</b>		Limit in BS EN 61000-3-12		
	Measure d Value MV in Amps	%	Measure d Value MV in Amps	%	1 phase	3 phase	
2	0.054	0.311	0.038	0.220	8%	8%	
3	0.163	0.937	0.132	0.760	21.6%	Not stated	
4	0.014	0.081	0.009	0.054	4%	4%	
5	0.063	0.360	0.100	0.575	10.7%	10.7%	
6	0.014	0.082	0.008	0.046	2.67%	2.67%	
7	0.036	0.207	0.054	0.313	7.2%	7.2%	
8	0.011	0.065	0.008	0.047	2%	2%	
9	0.029	0.169	0.034	0.197	3.8%	Not stated	
10	0.011	0.062	0.008	0.046	1.6%	1.6%	
11	0.016	0.091	0.020	0.112	3.1%	3.1%	
12	0.011	0.064	0.008	0.048	1.33%	1.33%	
13	0.013	0.075	0.020	0.112	2%	2%	
THD	--	1.41	--	1.73	23%	13%	
PWHD	--	1.40	--	1.29	23%	22%	

THD = Total Harmonic Distortion

PWHD = Partial Weighted Harmonic Distortion

G99/1-6			
Clause	Requirement - Test	Result - Remark	Verdict

<p><b>3. Power Quality – Voltage fluctuations and Flicker:</b></p> <p>For <b>Power Generating Modules</b> of <b>Registered Capacity</b> of less than 75 A per phase (ie 50 kW) these tests should be undertaken in accordance with Annex A.7.1.4.3. Results should be normalised to a standard source impedance, or if this results in figures above the limits set in BS EN 61000-3-11 to a suitable Maximum Impedance.</p> <p>For <b>Power Generating Modules</b> of <b>Registered Capacity</b> of greater than 75 A per phase (ie 50 kW) the installation shall be designed in accordance with EREC P28.</p>	<b>P</b>
-----------------------------------------------------------------------------------------------------------------------------------------------------------------------------------------------------------------------------------------------------------------------------------------------------------------------------------------------------------------------------------------------------------------------------------------------------------------------------------------------------------------------------------------------------------------------------------------------------------------	----------

Model: AF6K-SL

	Starting			Stopping			Running	
	d max	d c	d(t)	d max	d c	d(t)	Pst	Plt 2 hours
Measured Values at test impedance	0.56%	0.27	0	1.43%	0.16	0	0.22	0.19
Normalised to standard impedance	0.56%	0.27	0	1.43%	0.16	0	0.22	0.19
Normalised to required maximum impedance	N/A <sup>#</sup>	N/A	N/A	N/A	N/A	N/A	N/A	N/A
Limits set under BS EN 61000-3-11	4%	3.3%	3.3%	4%	3.3%	3.3%	1.0	0.65

Test Impedance	R	0.24	$\Omega$	XI	0.15	$\Omega$
Standard Impedance	R	0.24 <sup>*</sup> 0.4 <sup>^</sup>	$\Omega$	XI	0.15 <sup>*</sup> 0.25 <sup>^</sup>	$\Omega$
Maximum Impedance	R	N/A <sup>#</sup>	$\Omega$	XI	N/A <sup>#</sup>	$\Omega$

\* Applies to three phase and split single phase **Power Generating Modules**.

<sup>^</sup> Applies to single phase **Power Generating Module** and **Power Generating Modules** using two phases on a three phase system

<sup>#</sup> All the test value and calculated value normalised to standard impedance of  $d_{max\ test}$ ,  $d_{c\ test}$ ,  $d_{(t)\ test}$ ,  $P_{st\ test}$  and  $P_{lt\ test}$  were complies with the requirements of IEC 61000-3-11 and therefore is not subject to conditional connection, so the manufacturer no need to declare maximum Impedance.

G99/1-6			
Clause	Requirement - Test	Result - Remark	Verdict

For voltage change and flicker measurements the following formula is to be used to convert the measured values to the normalised values where the **Power Factor** of the generation output is 0.98 or above.

Normalised value = Measured value x reference source resistance/measured source resistance at test point

Single phase units reference source resistance is 0.4  $\Omega$

Two phase units in a three phase system reference source resistance is 0.4  $\Omega$

Two phase units in a split phase system reference source resistance is 0.24  $\Omega$

Three phase units reference source resistance is 0.24  $\Omega$

Where the **Power Factor** of the output is under 0.98 then the Xl to R ratio of the test impedance should be close to that of the Standard Impedance.

The stopping test should be a trip from full load operation.

The duration of these tests need to comply with the particular requirements set out in the testing notes for the technology under test.

G99/1-6			
Clause	Requirement - Test	Result - Remark	Verdict

**4. Power quality – DC injection:** The tests should be carried out on a single **Generating Unit**. Tests are to be carried out at three defined power levels  $\pm 5\%$ . At 230 V a 50 kW three phase **Inverter** has a current output of 217 A so DC limit is 543 mA. These tests should be undertaken in accordance with Annex A.7.1.4.4.

**P**

Model: AF6K-SL			
Test power level	10% Pn	55% Pn	100% Pn
Recorded value in Amps	0.040	0.042	0.042
as % of rated AC current	0.15%	0.16%	0.16%
Limit	0.25%	0.25%	0.25%

**Diagram of permanent dc-injection (10%/55%/100%Pn)**

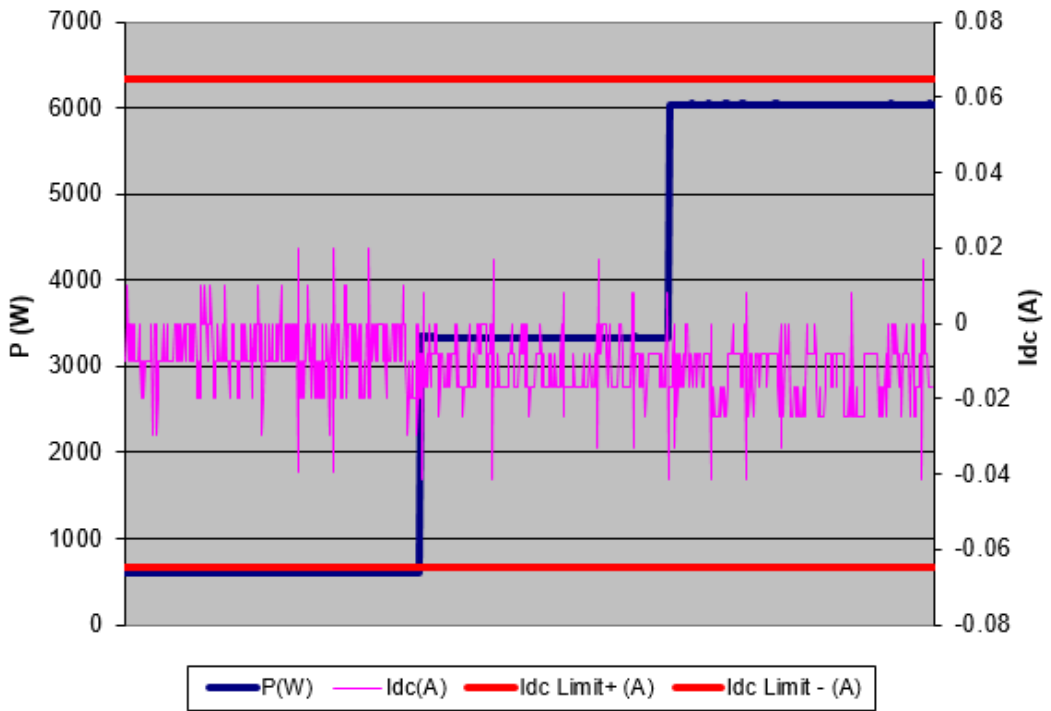



G99/1-6			
Clause	Requirement - Test	Result - Remark	Verdict

**4. Power quality – DC injection:** The tests should be carried out on a single **Generating Unit**. Tests are to be carried out at three defined power levels  $\pm 5\%$ . At 230 V a 50 kW three phase **Inverter** has a current output of 217 A so DC limit is 543 mA. These tests should be undertaken in accordance with Annex A.7.1.4.4.

**P**

Model: AF4K-SL			
Test power level	10% Pn	55% Pn	100% Pn
Recorded value in Amps	0.030	0.030	0.029
as % of rated AC current	0.17%	0.17%	0.17%
Limit	0.25%	0.25%	0.25%

**Diagram of permanent dc-injection (10%/55%/100%Pn)**

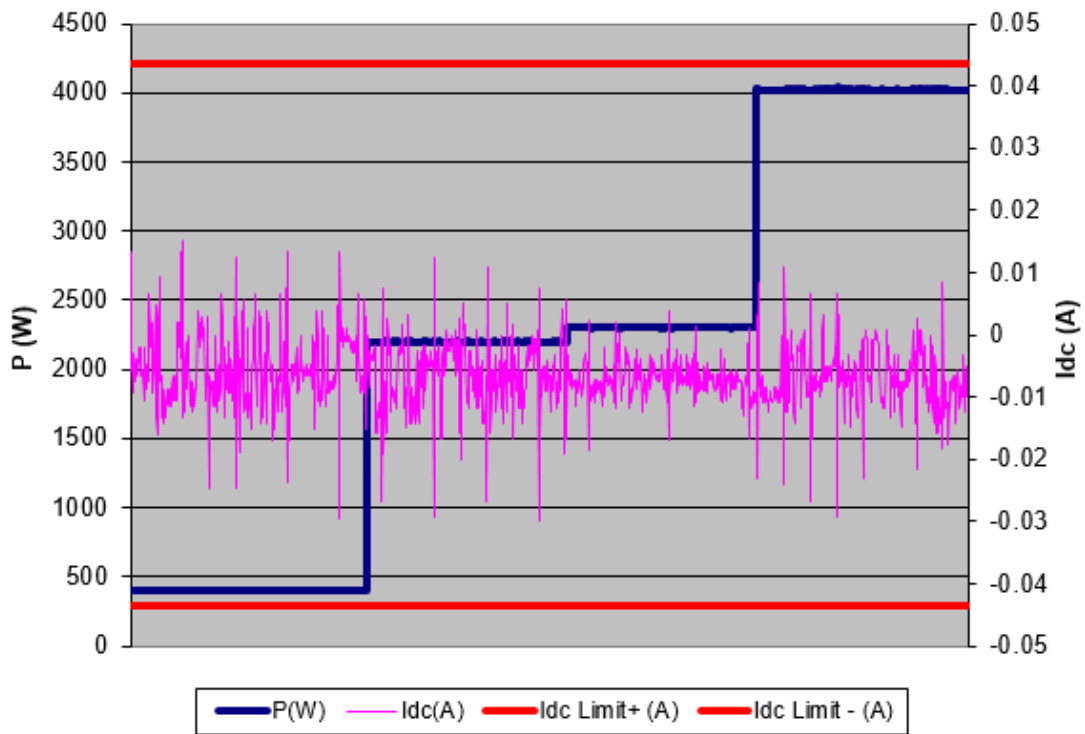

G99/1-6			
Clause	Requirement - Test	Result - Remark	Verdict

<p><b>5. Power Factor:</b> The tests should be carried out on a single <b>Power Generating Module</b>. Tests are to be carried out at three voltage levels and at <b>Registered Capacity</b>. Voltage to be maintained within <math>\pm 1.5\%</math> of the stated level during the test. These tests should be undertaken in accordance with Annex A.7.1.4.2.</p>			<b>P</b>
Model: AF6K-SL			
Voltage	0.94 pu (216.2 V)	1 pu (230 V)	1.1 pu (253 V)
Measured value	0.9996	0.9996	0.9987
<b>Power Factor</b> Limit	>0.95	>0.95	>0.95

<p><b>5. Power Factor:</b> The tests should be carried out on a single <b>Power Generating Module</b>. Tests are to be carried out at three voltage levels and at <b>Registered Capacity</b>. Voltage to be maintained within <math>\pm 1.5\%</math> of the stated level during the test. These tests should be undertaken in accordance with Annex A.7.1.4.2.</p>			<b>P</b>
Model: AF4K-SL			
Voltage	0.94 pu (216.2 V)	1 pu (230 V)	1.1 pu (253 V)
Measured value	0.9996	0.9996	0.9989
<b>Power Factor</b> Limit	>0.95	>0.95	>0.95

G99/1-6			
Clause	Requirement - Test	Result - Remark	Verdict

6. Protection – Frequency tests: These tests should be carried out in accordance with the Annex A.7.1.2.3.						P
Model: AF6K-SL						
Function	Setting		Trip test		“No trip tests”	
	Frequency	Time delay	Frequency	Time delay	Frequency /time	Confirm no trip
U/F stage 1	47.5 Hz	20 s	47.48 Hz	20.3 s	47.7 Hz 30 s	No trip
U/F stage 2	47 Hz	0.5 s	46.98 Hz	0.540 s	47.2 Hz 19.5 s	No trip
					46.8 Hz 0.45 s	No trip
O/F	52 Hz	0.5 s	52.02 Hz	0.548 s	51.8 Hz 120 s	No trip
					52.2 Hz 0.45 s	No trip
<p>Note: For frequency trip tests the frequency required to trip is the setting <math>\pm 0.1</math> Hz. In order to measure the time delay a larger deviation than the minimum required to operate the projection can be used. The “No trip tests” need to be carried out at the setting <math>\pm 0.2</math> Hz and for the relevant times as shown in the table above to ensure that the protection will not trip in error.</p> <p>The PV inverter nominal AC output frequency value is 50Hz.</p> <p>The tests were performed on model AF6K-SL also applicable for all other models stated in this report.</p>						

G99/1-6			
Clause	Requirement - Test	Result - Remark	Verdict

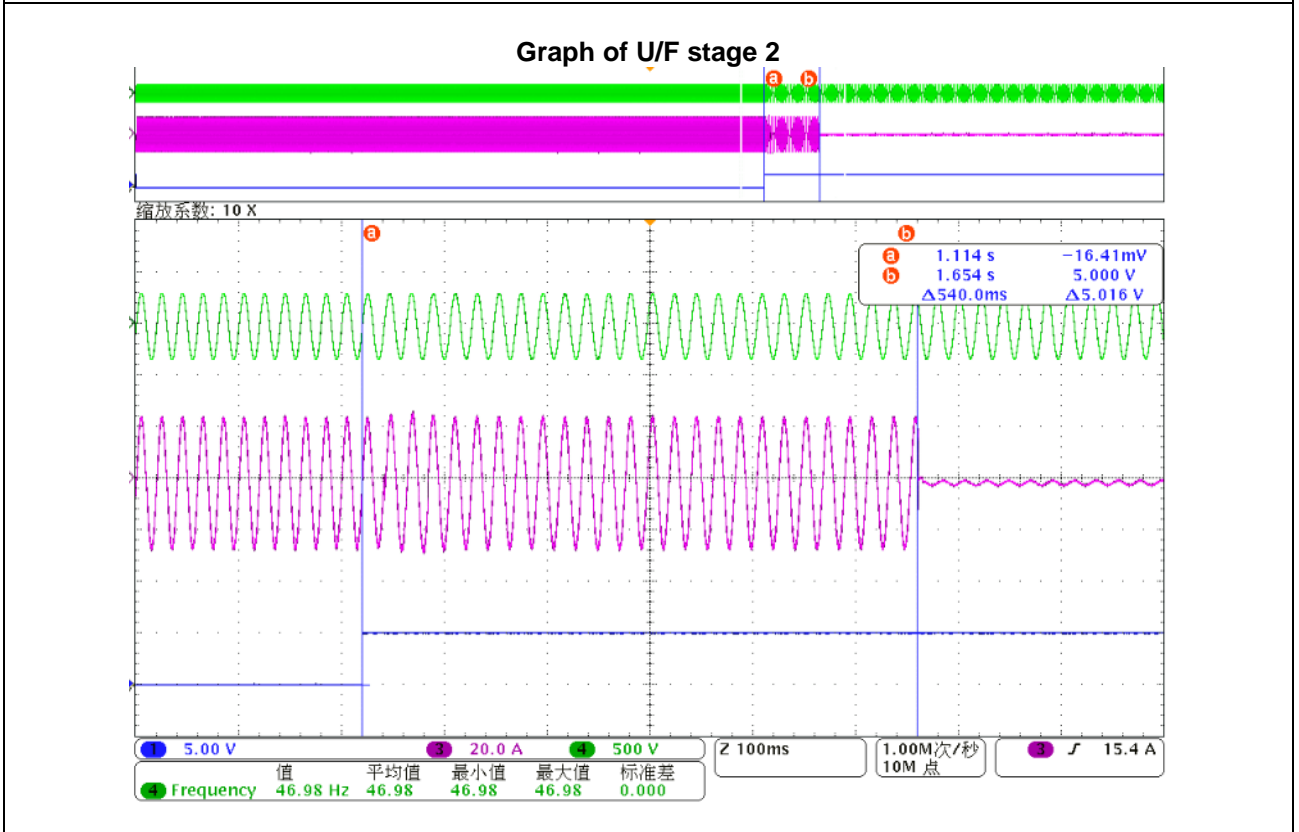
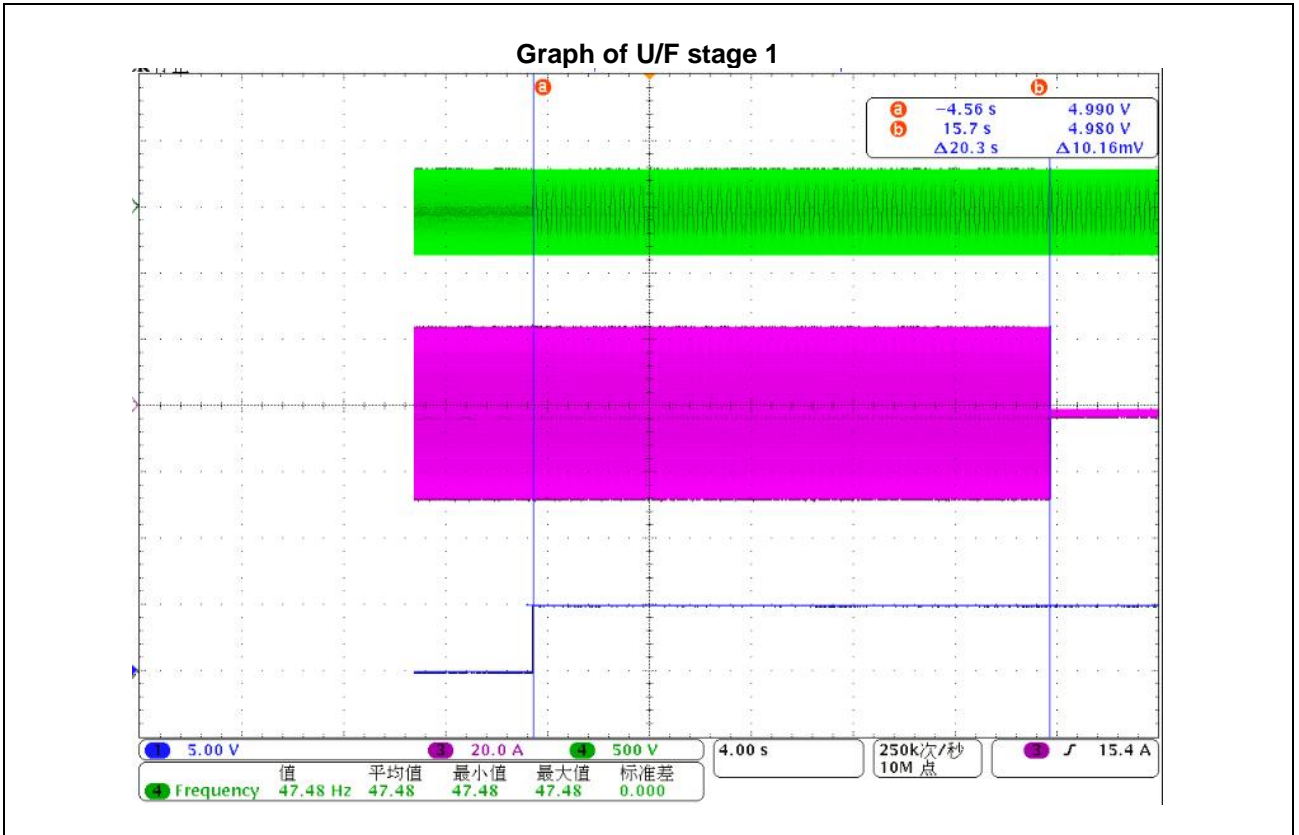

G99/1-6			
Clause	Requirement - Test	Result - Remark	Verdict

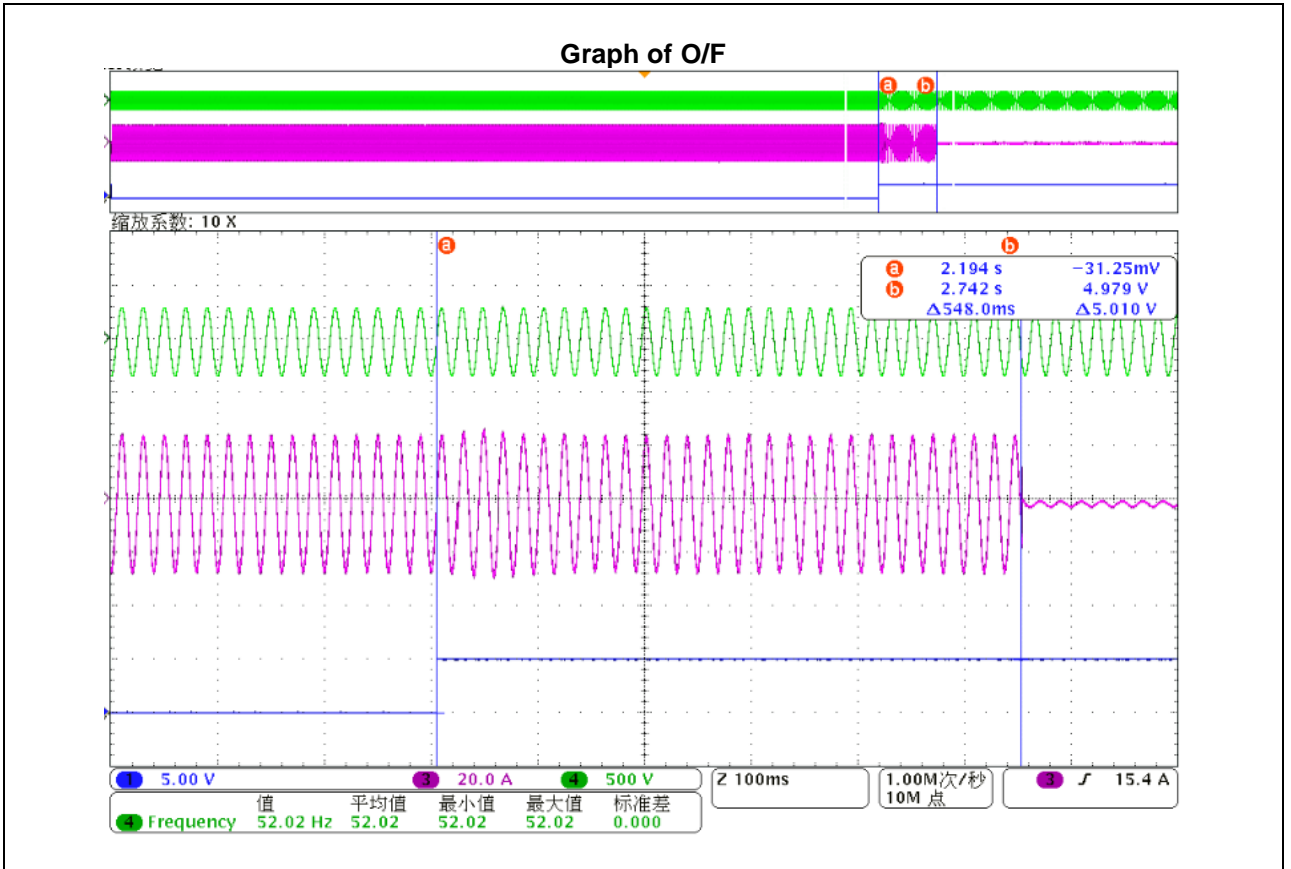

G99/1-6			
Clause	Requirement - Test	Result - Remark	Verdict

7. Protection – Voltage tests: These tests should be carried out in accordance with Annex A.7.1.2.2.						P
Model: AF6K-SL						
Function	Setting		Trip test		“No trip tests”	
	Voltage	Time delay	Voltage	Time delay	Voltage /time	Confirm no trip
U/V	0.8 pu (184 V)	2.5 s	180.6 V	2.520 s	188 V 5.0 s	No trip
					180 V 2.45 s	No trip
O/V stage 1	1.14 pu (262.2 V)	1.0 s	265.1 V	1.052 s	258.2 V 5.0 s	No trip
O/V stage 2	1.19 pu (273.7 V)	0.5 s	277.0 V	0.536 s	269.7 V 0.95 s	No trip
					277.7 V 0.45 s	No trip

Note for Voltage tests the Voltage required to trip is the setting  $\pm 3.45$  V. The time delay can be measured at a larger deviation than the minimum required to operate the protection. The No trip tests need to be carried out at the setting  $\pm 4$  V and for the relevant times as shown in the table above to ensure that the protection will not trip in error.

The Hybrid inverter nominal AC output voltage value is 230 V phase to neutral.

The tests were performed on model AF6K-SL also applicable for all other models stated in this report.

G99/1-6			
Clause	Requirement - Test	Result - Remark	Verdict

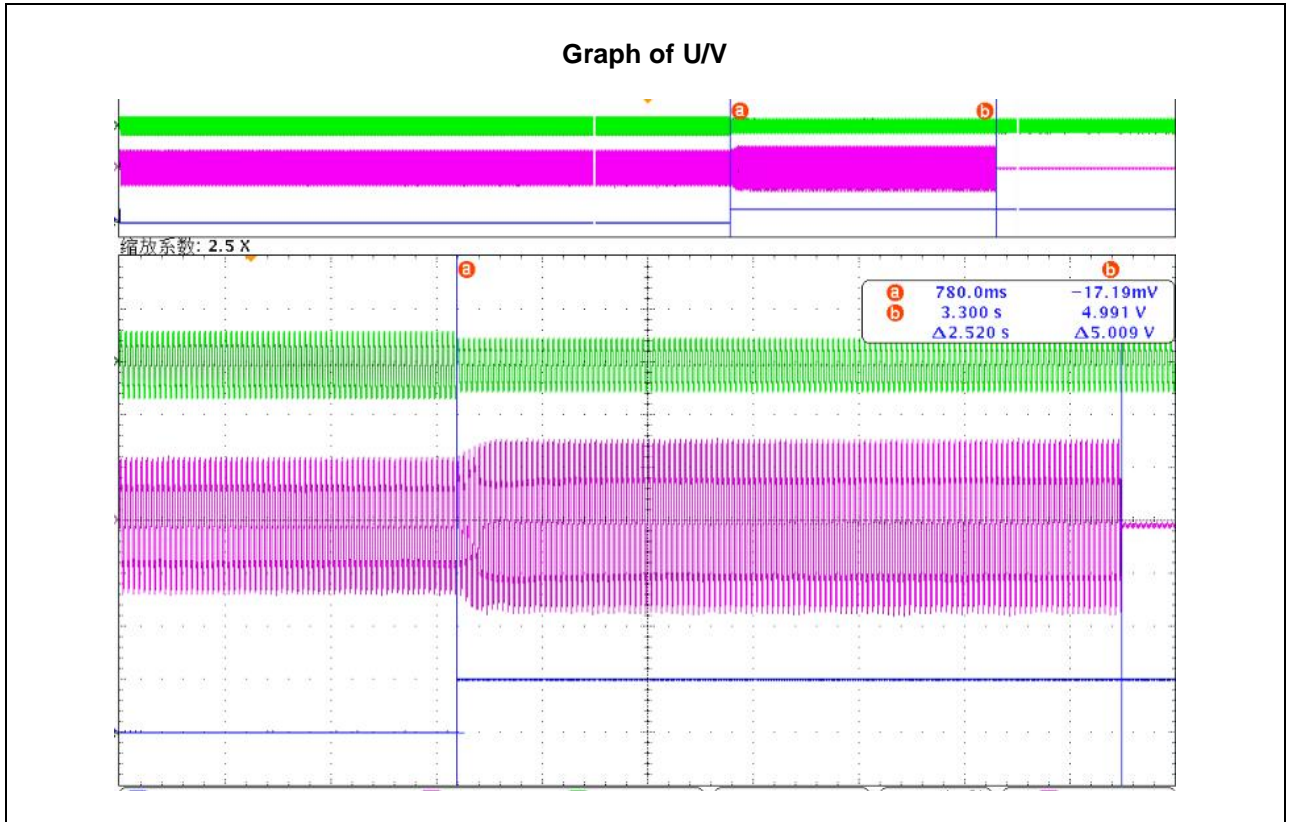

G99/1-6			
Clause	Requirement - Test	Result - Remark	Verdict

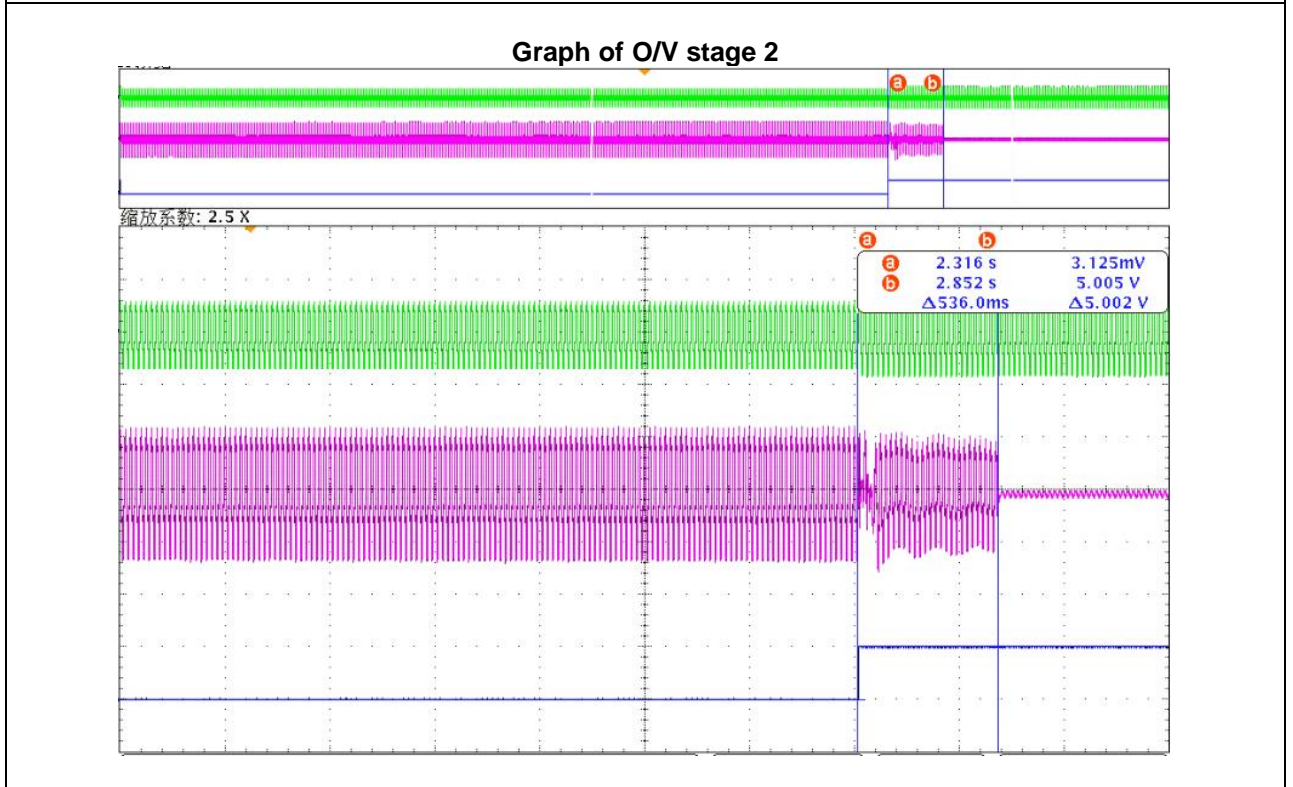
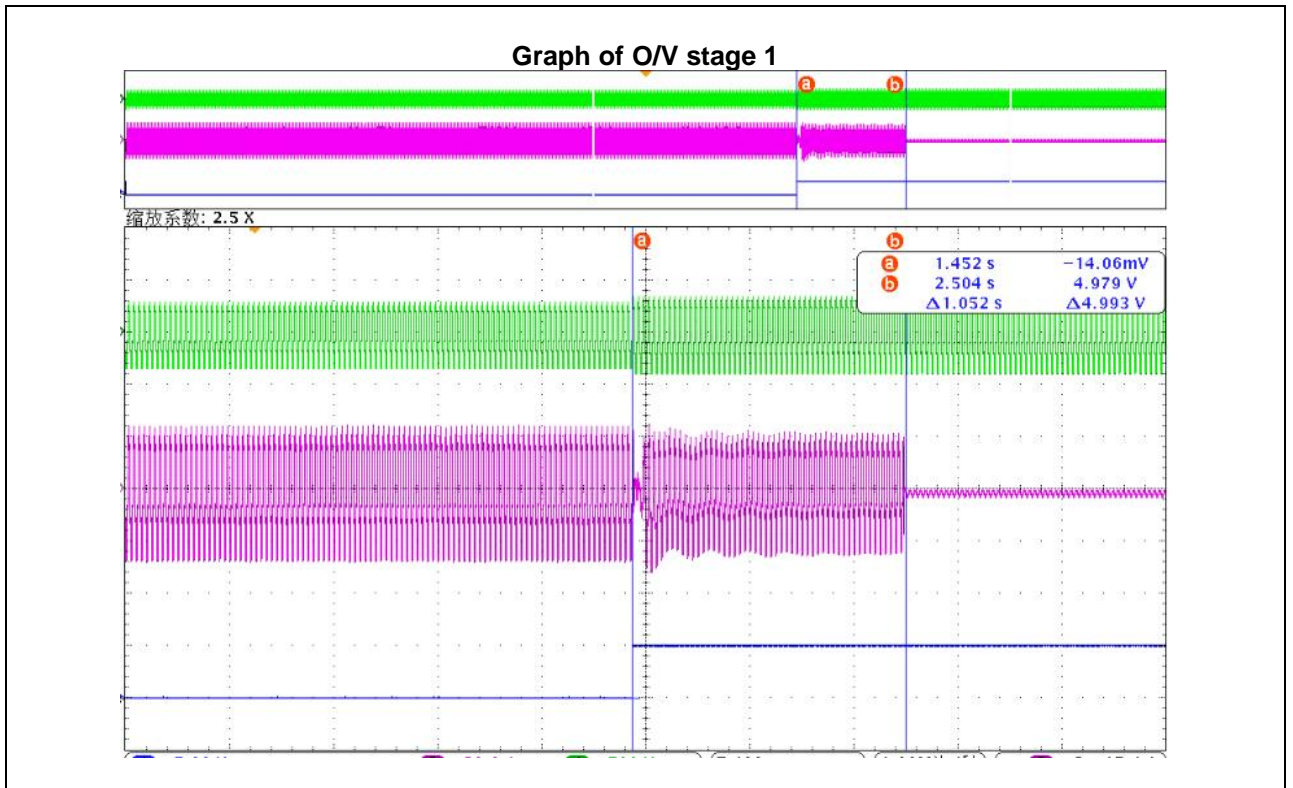



G99/1-6			
Clause	Requirement - Test	Result - Remark	Verdict

8. Protection – Loss of Mains test: These tests should be carried out in accordance with BS EN 62116. Annex A.7.1.2.4.									P
The following sub set of tests should be recorded in the following table.									
Model: AF6K-SL									
Test Power and imbalance	33% -5% Q Test 22	66% -5% Q Test 12	100% -5% P Test 5	33% +5% Q Test 31	66% +5% Q Test 21	100% +5% P Test 10			
Trip time. Limit is 0.5 s	82.4 ms	75.6 ms	81.2 ms	74.4 ms	66.4 ms	75.6 ms			
No	$P_{EUT}^{a)}$ (% of EUT rating)	Reactive load (% of $Q_L$ in 6.1.d) 1)	$P_{ac}^{b)}$ (% of nominal)	$Q_{ac}^{c)}$ (% of nominal)	Run on Time (ms)	$P_{EUT}$ (kW)	Actual $Q_f$	$V_{DC}^{d)}$	Remarks $e)$
Test condition A (EUT output = 100%)									
1	100	100	0	0	96.4	6.0	1.00	392	Test A at BL
2	100	100	0	-5	78.7	6.0	0.97	392	Test A at IB
3	100	100	0	+5	62.8	6.0	1.02	392	Test A at IB
4	100	100	-5	-5	64.0	6.0	1.03	392	Test A at IB
5	100	100	-5	0	81.2	6.0	1.05	392	Test A at IB
6	100	100	-5	+5	69.2	6.0	1.08	392	Test A at IB
7	100	100	+5	-5	66.8	6.0	0.96	392	Test A at IB
8	100	100	+5	0	75.6	6.0	0.94	392	Test A at IB
9	100	100	+5	+5	71.2	6.0	0.98	392	Test A at IB
10	100	100	-5	-10	78.4	6.0	1.00	392	Test A at IB
11	100	100	-5	+10	58.0	6.0	1.10	392	Test A at IB
12	100	100	0	-10	78.0	6.0	0.95	392	Test A at IB
13	100	100	0	+10	62.4	6.0	1.05	392	Test A at IB
14	100	100	+5	-10	77.6	6.0	0.9	392	Test A at IB
15	100	100	+5	+10	72.8	6.0	1.00	392	Test A at IB
16	100	100	-10	-10	66.4	6.0	1.05	392	Test A at IB
17	100	100	-10	-5	80.0	6.0	1.08	392	Test A at IB
18	100	100	-10	0	76.8	6.0	1.11	392	Test A at IB
19	100	100	-10	+5	82.4	6.0	1.14	392	Test A at IB
20	100	100	-10	+10	67.2	6.0	1.17	392	Test A at IB
21	100	100	+10	-10	81.2	6.0	0.86	392	Test A at IB
22	100	100	+10	-5	90.0	6.0	0.89	392	Test A at IB
23	100	100	+10	0	96.8	6.0	0.91	392	Test A at IB
24	100	100	+10	+5	68.8	6.0	0.93	392	Test A at IB

G99/1-6									
Clause	Requirement - Test					Result - Remark			Verdict
25	100	100	+10	+10	72.8	6.0	0.95	392	Test A at IB

8. Protection – Loss of Mains test: These tests should be carried out in accordance with BS EN 62116. Annex A.7.1.2.4.									P
The following sub set of tests should be recorded in the following table									
Model: AF6K-SL									
Test condition B (EUT output = 50 % – 66 %)									
No	$P_{EUT}^{a)}$ (% of EUT rating)	Reactive load (% of $Q_L$ in 6.1.d.1)	$P_{ac}^{b)}$ (% of nominal)	$Q_{ac}^{c)}$ (% of nominal)	Run on Time (ms)	$P_{EUT}$ (kW)	Actual $Q_f$	$V_{DC}^{d)}$	Remarks $^{e)}$
1	66	66	0	-5	75.6	3300	0.97	305	Test B at IB
2	66	66	0	-4	75.2	3300	0.98	305	Test B at IB
3	66	66	0	-3	89.2	3300	0.98	305	Test B at IB
4	66	66	0	-2	94.4	3300	0.99	305	Test B at IB
5	66	66	0	-1	103.6	3300	0.99	305	Test B at IB
6	66	66	0	0	122.8	3300	1.00	305	Test B at BL
7	66	66	0	+1	99.6	3300	1.00	305	Test B at IB
8	66	66	0	+2	89.2	3300	1.01	305	Test B at IB
9	66	66	0	+3	83.2	3300	1.01	305	Test B at IB
10	66	66	0	+4	77.6	3300	1.02	305	Test B at IB
11	66	66	0	+5	66.4	3300	1.02	305	Test B at IB

G99/1-6			
Clause	Requirement - Test	Result - Remark	Verdict

<b>8. Protection – Loss of Mains test:</b> These tests should be carried out in accordance with BS EN 62116. Annex A.7.1.2.4.									<b>P</b>
The following sub set of tests should be recorded in the following table									
Model: AF6K-SL									
<b>Test condition C (EUT output = 25 % – 33 %)</b>									
No	$P_{EUT}^{a)}$ (% of EUT rating)	Reactive load (% of $Q_L$ in 6.1.d) 1)	$P_{ac}^{b)}$ (% of nominal)	$Q_{ac}^{c)}$ (% of nominal)	Run on Time (ms)	$P_{EUT}$ (kW)	Actual $Q_f$	$V_{DC}^{d)}$	Remarks $e)$
1	33	33	0	-5	82.4	1.99	0.97	150	Test C at IB
2	33	33	0	-4	90.8	1.99	0.98	150	Test C at IB
3	33	33	0	-3	98.4	1.99	0.98	150	Test C at IB
4	33	33	0	-2	101.6	1.99	0.99	150	Test C at IB
5	33	33	0	-1	106.0	1.99	0.99	150	Test C at IB
6	33	33	0	0	132.8	1.99	1.00	150	Test C at BL
7	33	33	0	+1	105.2	1.99	1.00	150	Test C at IB
8	33	33	0	+2	101.2	1.99	1.01	150	Test C at IB
9	33	33	0	+3	93.6	1.99	1.01	150	Test C at IB
10	33	33	0	+4	83.2	1.99	1.02	150	Test C at IB
11	33	33	0	+5	74.4	1.99	1.02	150	Test C at IB
<p>Note:</p> <p>a) <math>P_{EUT}</math>: EUT output power</p> <p>b) <math>P_{ac}</math>: Active power flow at S1 in Figure 1. Positive means power from EUT to utility. Nominal is the 0 % test condition value.</p> <p>c) <math>Q_{ac}</math>: Reactive power flow at S1 in Figure 1. Positive means power from EUT to utility. Nominal is the 0 % test condition value.</p> <p>d) For test condition A, &gt; 75 % of rated input voltage range used, for test condition B, 50 % of rated input voltage range, <math>\pm 10</math> % used, for test condition C, &lt; 20 % of rated input voltage range used. Based on EUT rated input operating range. For example, if range is between X volts and Y volts, 75 % of range = <math>X + 0,75 \times (Y - X)</math>. Y shall not exceed <math>0,8 \times</math> EUT maximum system voltage (i.e., maximum allowable array open circuit voltage). In any case, the EUT should not be operated outside of its allowable input voltage range.</p> <p>e) BL: Balance condition, IB: Imbalance condition.</p> <p>For technologies which have a substantial shut down time this can be added to the 0,5s in establishing that the trip occurred in less than 0,5s maximum. Shut down time could therefore be up to 1,0s for these technologies.</p> <p>The tests were performed on model AF6K-SL also applicable for all other models stated in this report.</p>									

G99/1-6			
Clause	Requirement - Test	Result - Remark	Verdict

**Graph of disconnection at  $P_{AC}$  10 and  $Q_{AC}$  0 reactive load and 100% nominal power**

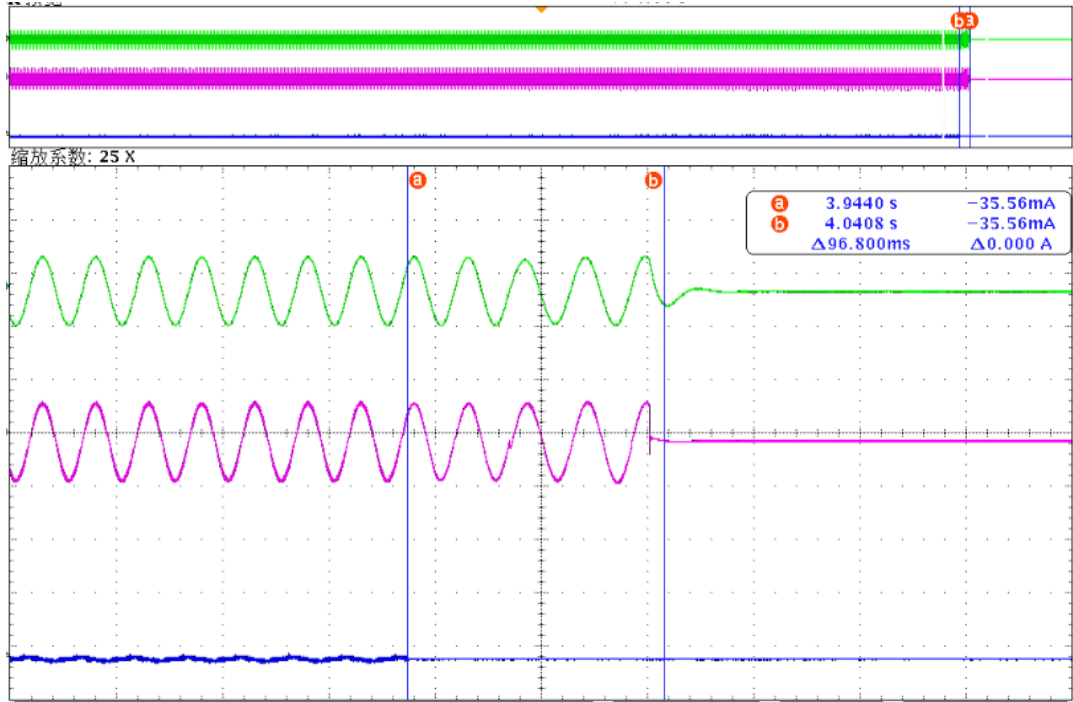

**Graph of disconnection at  $P_{AC}$  0 and  $Q_{AC}$  0 reactive load and 66% nominal power**

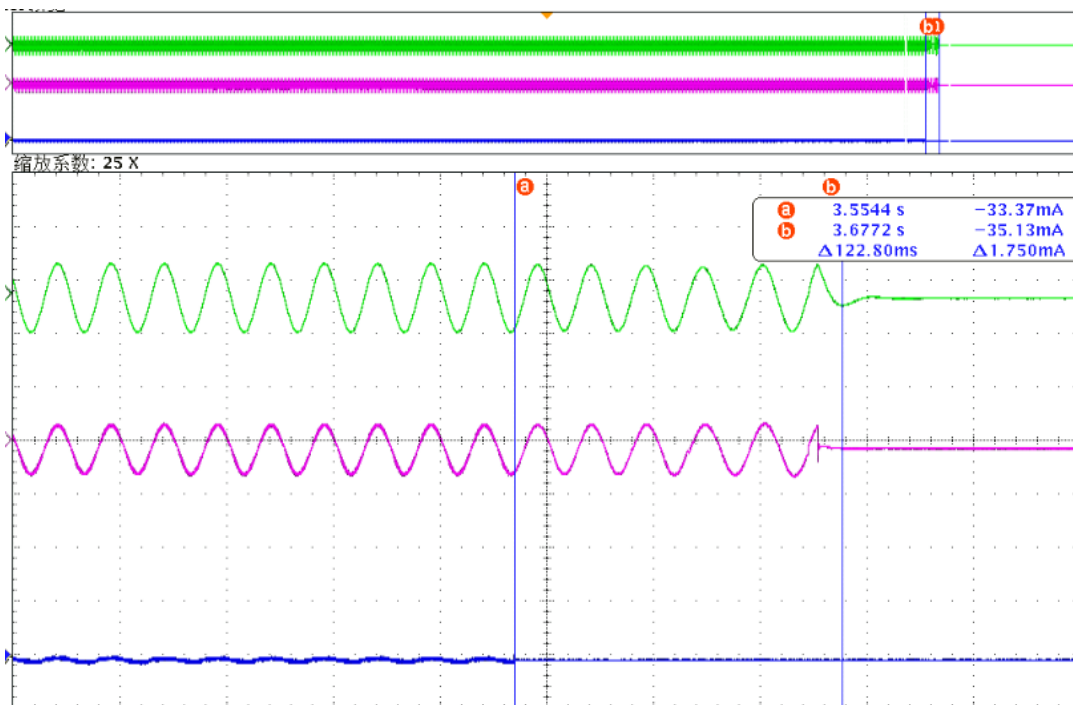

G99/1-6			
Clause	Requirement - Test	Result - Remark	Verdict

**Graph of disconnection at  $P_{AC}$  0 and  $Q_{AC}$  0 reactive load and 33% nominal power**

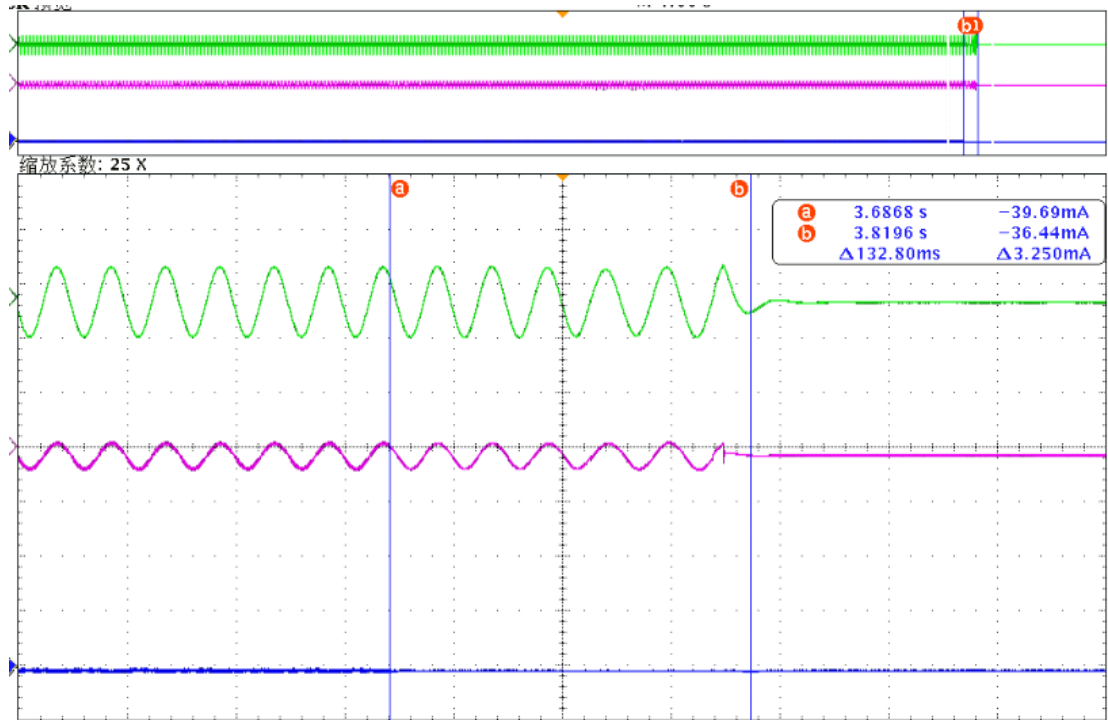

G99/1-6			
Clause	Requirement - Test	Result - Remark	Verdict

<b>Loss of Mains Protection, Vector Shift Stability test.</b> This test should be carried out in accordance with Annex A.7.1.2.6.			<b>P</b>
Model: AF6K-SL			
Vector Shift	Start Frequency	Change	Confirm no trip
Positive Vector Shift	49.0 Hz	+50 degrees	No trip
Negative Vector Shift	50.0 Hz	- 50 degrees	No trip

<b>Loss of Mains Protection, RoCoF Stability test:</b> This test should be carried out in accordance with Annex A.7.1.2.6.			<b>P</b>
Model: AF6K-SL			
Ramp range	Test frequency ramp:	Test Duration	Confirm no trip
49.0 Hz to 51.0 Hz	+0.95 Hzs <sup>-1</sup>	2.1 s	No trip
51.0 Hz to 49.0 Hz	-0.95 Hzs <sup>-1</sup>	2.1 s	No trip

G99/1-6			
Clause	Requirement - Test	Result - Remark	Verdict

<p><b>9. Limited Frequency Sensitive Mode – Over frequency test:</b> The test should be carried out using the specific threshold frequency of 50.4 Hz and <b>Droop</b> of 10%.</p> <p>This test should be carried out in accordance with Annex A.7.1.3.</p>	<b>P</b>
-------------------------------------------------------------------------------------------------------------------------------------------------------------------------------------------------------------------------------------------------------------	----------

<p><b>Active Power</b> response to rising frequency/time plots are attached if frequency injection tests are undertaken in accordance with Annex A.7.2.4.</p>	<b>Y/N</b>
---------------------------------------------------------------------------------------------------------------------------------------------------------------	------------

Alternatively, simulation results should be noted below:

Model: AF6K-SL

Test sequence at Registered Capacity >80%	Measured Active Power Output (W)	Frequency (Hz)	Calculate droop (%)	Primary Power Source	Active Power Gradient
Step a) 50.00 Hz ±0.01 Hz	6028.0	50.00	-	Photovoltaic array simulator	-
Step b) 50.45 Hz ±0.05 Hz	5963.3	50.45	9.32		-
Step c) 50.70 Hz ±0.10 Hz	5640.7	50.70	9.34		-
Step d) 51.15 Hz ±0.05 Hz	5100.6	51.15	9.74		-
Step e) 50.70 Hz ±0.10 Hz	5641.9	50.70	9.36		-
Step f) 50.45 Hz ±0.05 Hz	5965.6	50.45	9.66		-
Step g) 50.00 Hz ±0.01 Hz	6010.3	50.00	-		10%

**Diagram**

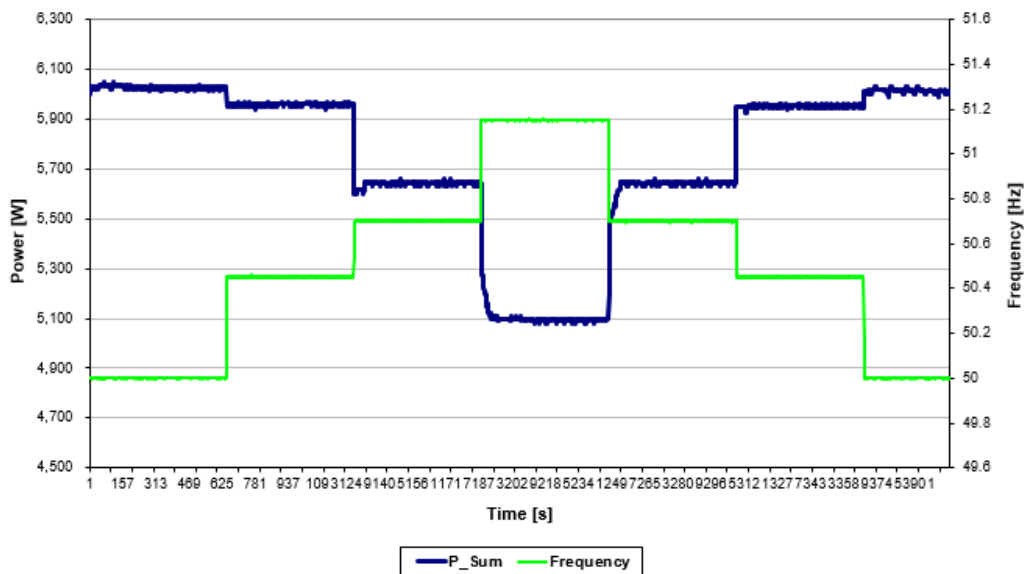

G99/1-6			
Clause	Requirement - Test	Result - Remark	Verdict

Test sequence at <b>Registered Capacity</b> 40% - 60%	Measured <b>Active Power</b> Output (W)	Frequency (Hz)	Calculate droop (%)	Primary Power Source	<b>Active Power Gradient</b>
Step a) 50.00 Hz ±0.01 Hz	3016.1	50.00	-	Photovoltaic array simulator	-
Step b) 50.45 Hz ±0.05 Hz	2984.5	50.45	9.54		-
Step c) 50.70 Hz ±0.10 Hz	2829.3	50.70	9.69		-
Step d) 51.15 Hz ±0.05 Hz	2527.5	51.15	9.26		-
Step e) 50.70 Hz ±0.10 Hz	2829.2	50.70	9.68		-
Step f) 50.45 Hz ±0.05 Hz	2983.7	50.45	9.31		-
Step g) 50.00 Hz ±0.01 Hz	3016.2	50.00	-		10%

Diagram

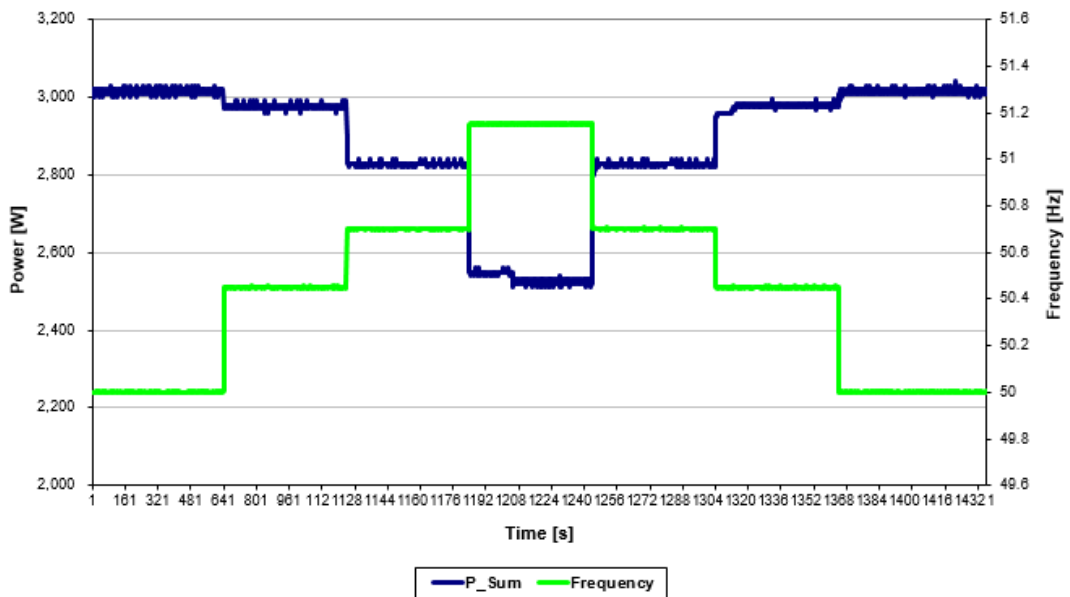



G99/1-6			
Clause	Requirement - Test	Result - Remark	Verdict

10. Protection – Re-connection timer.			P		
Model: AF6K-SL					
Test should prove that the reconnection sequence starts after a minimum delay of 20 s for restoration of voltage and frequency to within the stage 1 settings of Table 10.1.					
Time delay setting	Measured delay	Checks on no reconnection when voltage or frequency is brought to just outside stage 1 limits of Table 10.1.			
30 s	31 s	At 1.16 pu (266.2 V)	At 0.78 pu (180.0 V)	At 47.4 Hz	At 52.1 Hz
Confirmation that the <b>Micro-generator</b> does not re-connect.		No reconnection	No reconnection	No reconnection	No reconnection

11. Fault level contribution: These tests shall be carried out in accordance with EREC G99 Annex A.7.1.5.			P
For <b>Inverter</b> output			
Time after fault	Volts	Amps	
20ms	177.9 V	18.82 A	
100ms	1.076 V	0.15 A	
250ms	0	0	
500ms	0	0	
Time to trip	0.083	In seconds	

G99/1-6			
Clause	Requirement - Test	Result - Remark	Verdict

<b>12. Self-Monitoring solid state switching:</b> No specified test requirements. Refer to Annex A.7.1.7.			
It has been verified that in the event of the solid state switching device failing to disconnect the <b>Power Park Module</b> , the voltage on the output side of the switching device is reduced to a value below 50 volts within 0.5 s.			N/A
<b>13. Wiring functional tests:</b> If required by para 15.2.1.			
Confirm that the relevant test schedule is attached (tests to be undertaken at time of commissioning)			N/A
<b>14. Logic interface (input port).</b>			
Confirm that an input port is provided and can be used to shut down the module.			Yes
Additional comments.			
No.			

G99/1-6			
Clause	Requirement - Test	Result - Remark	Verdict

**Appendix 2: Photo documentation**

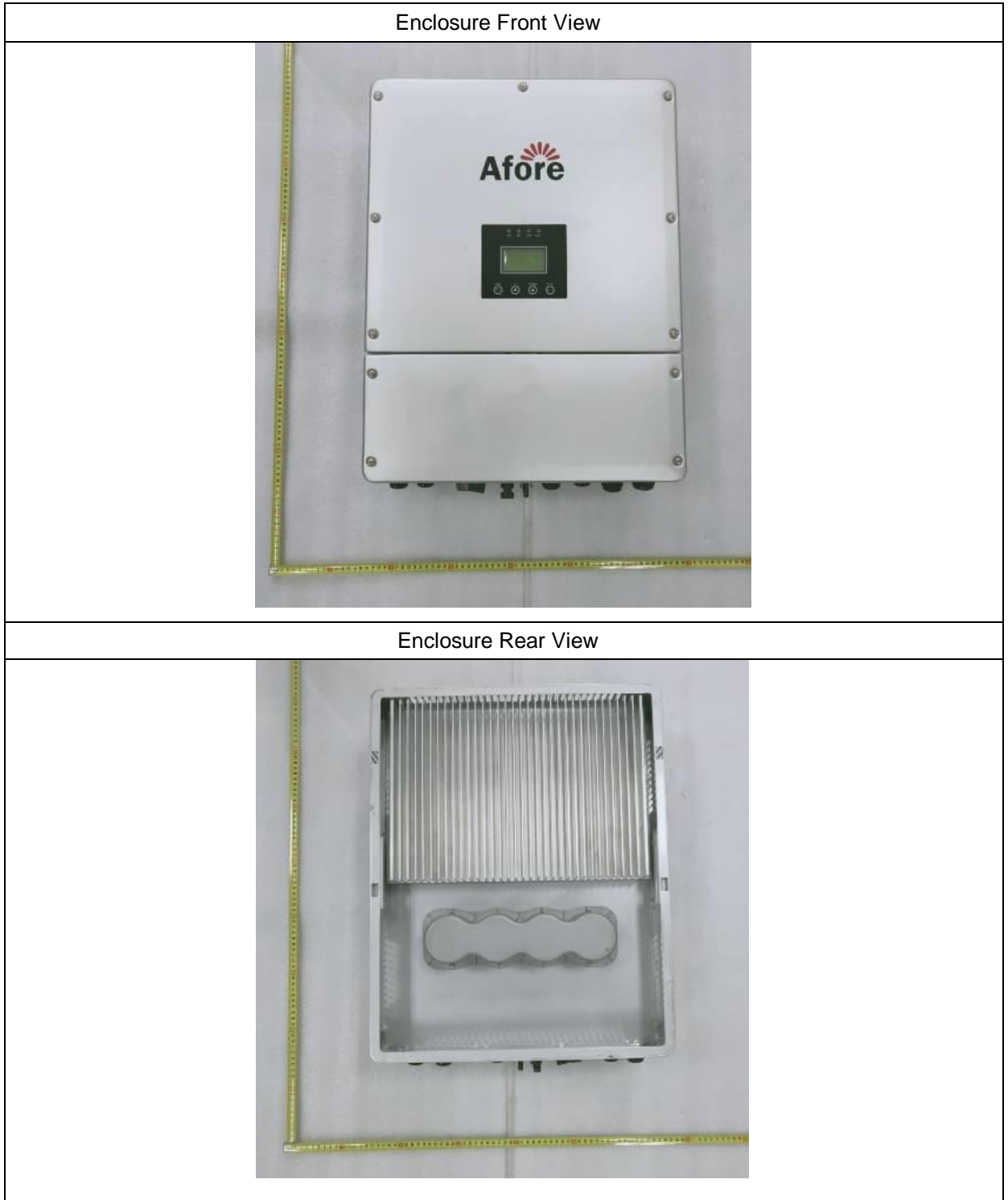

G99/1-6			
Clause	Requirement - Test	Result - Remark	Verdict

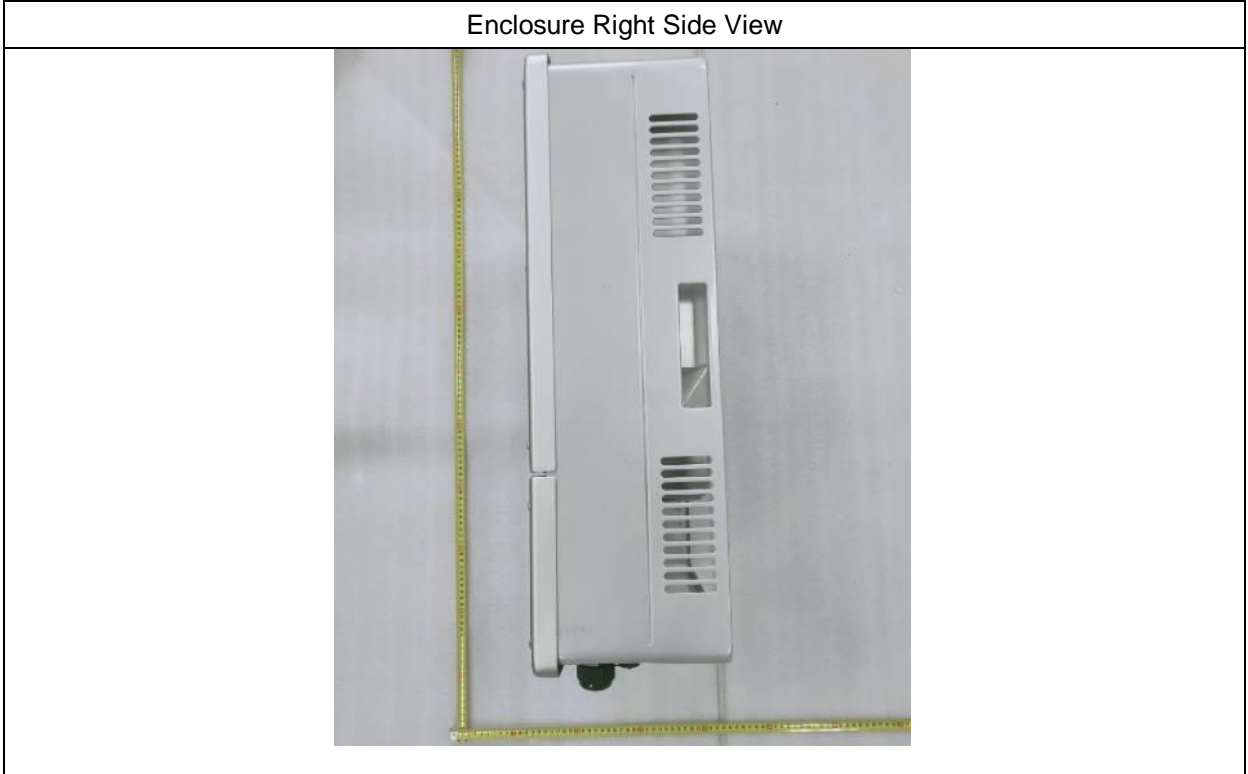
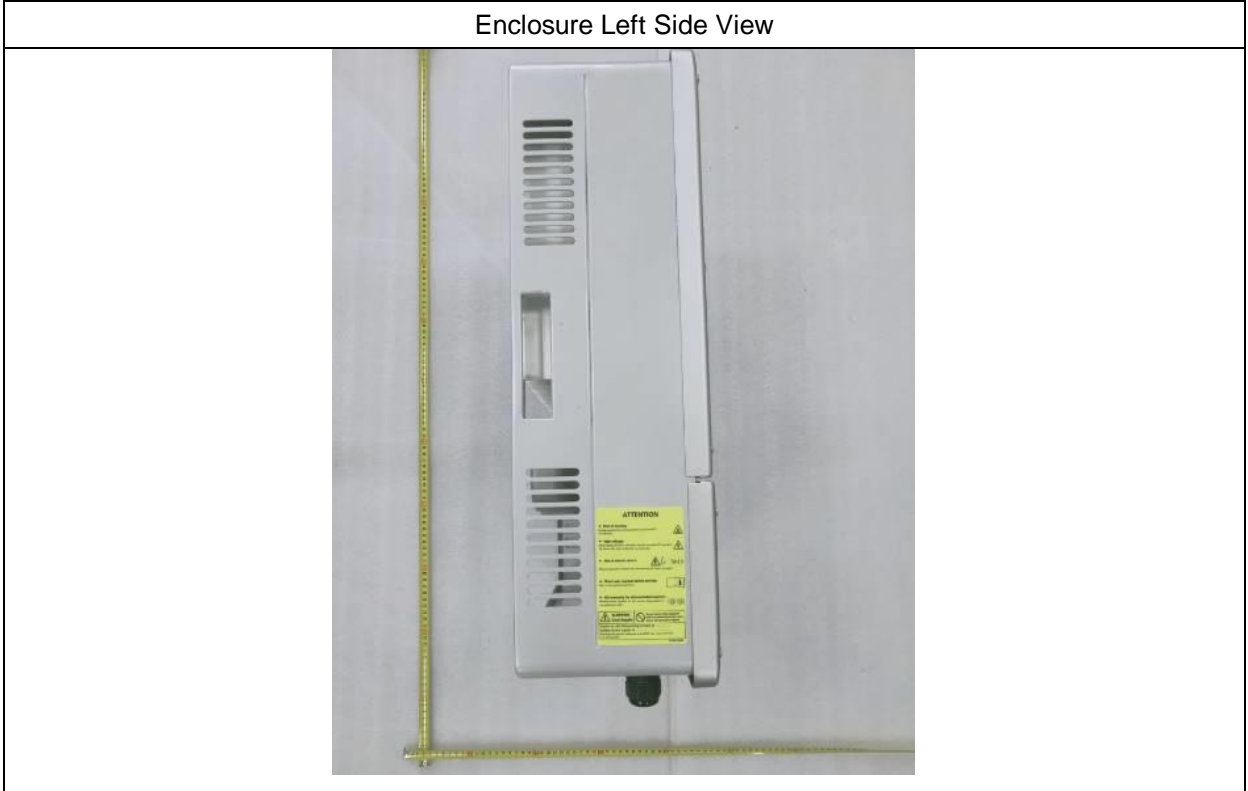

G99/1-6			
Clause	Requirement - Test	Result - Remark	Verdict

Enclosure Top Side View



Enclosure Bottom Side View



G99/1-6			
Clause	Requirement - Test	Result - Remark	Verdict

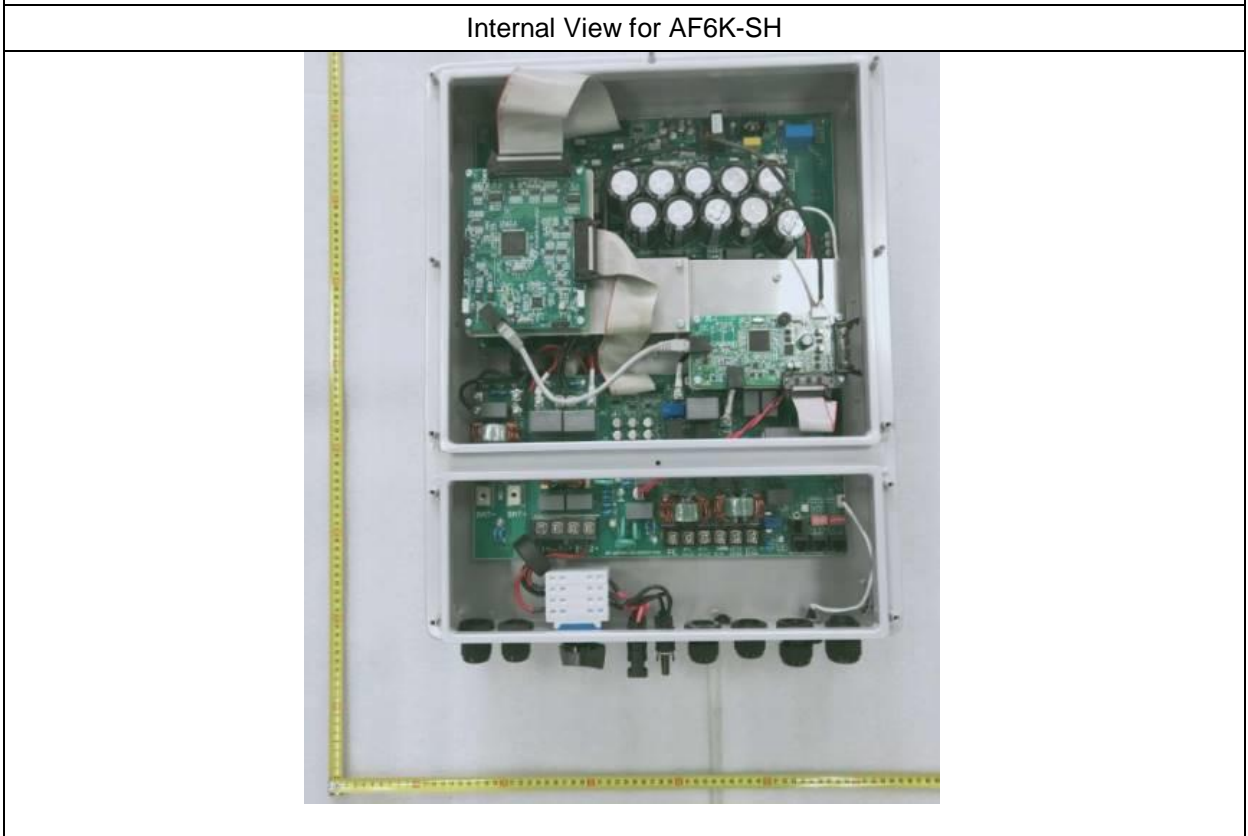
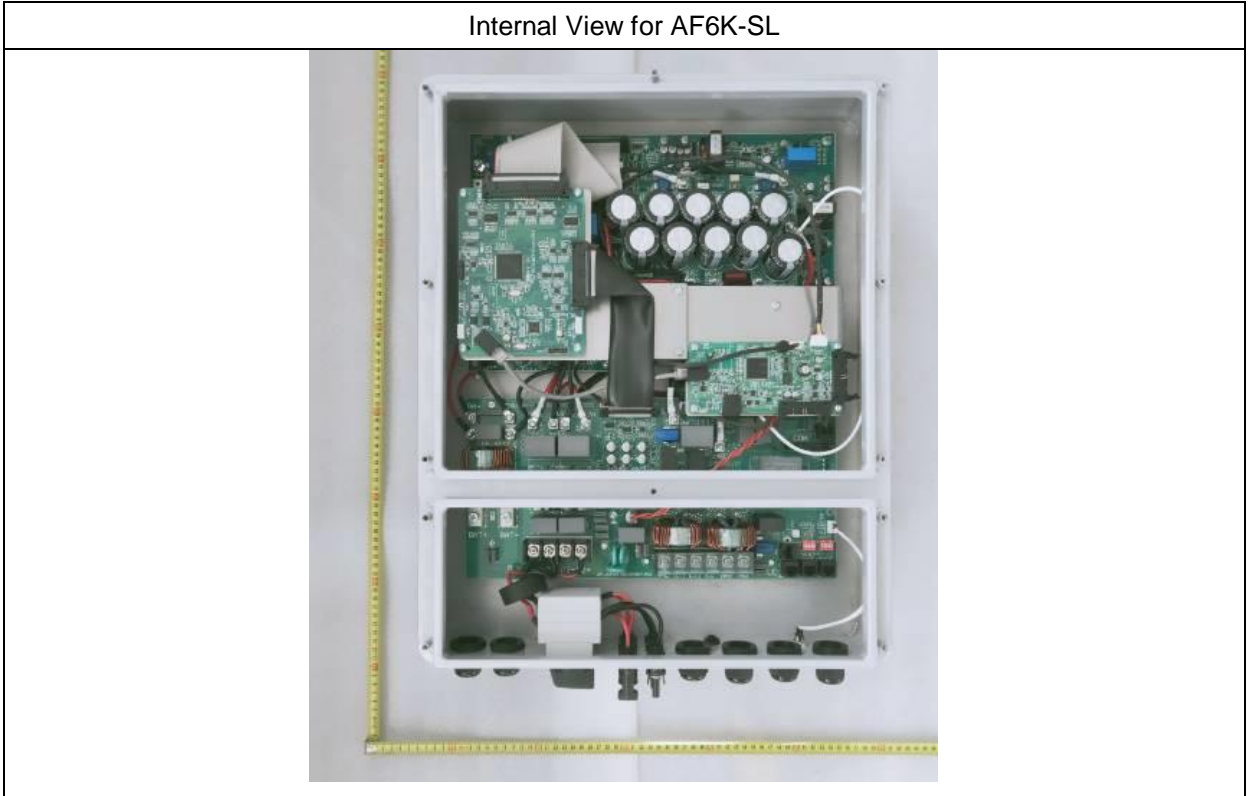

G99/1-6

Clause	Requirement - Test	Result - Remark	Verdict
--------	--------------------	-----------------	---------

Main Board – Component Side (AF6K-SL)

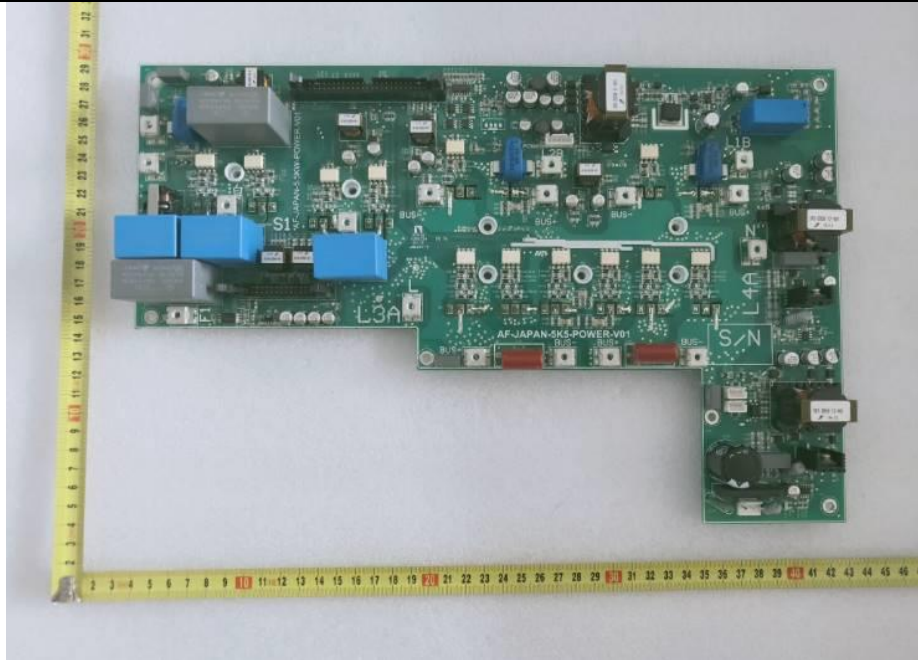

Main Board – Solder Side (AF6K-SL)

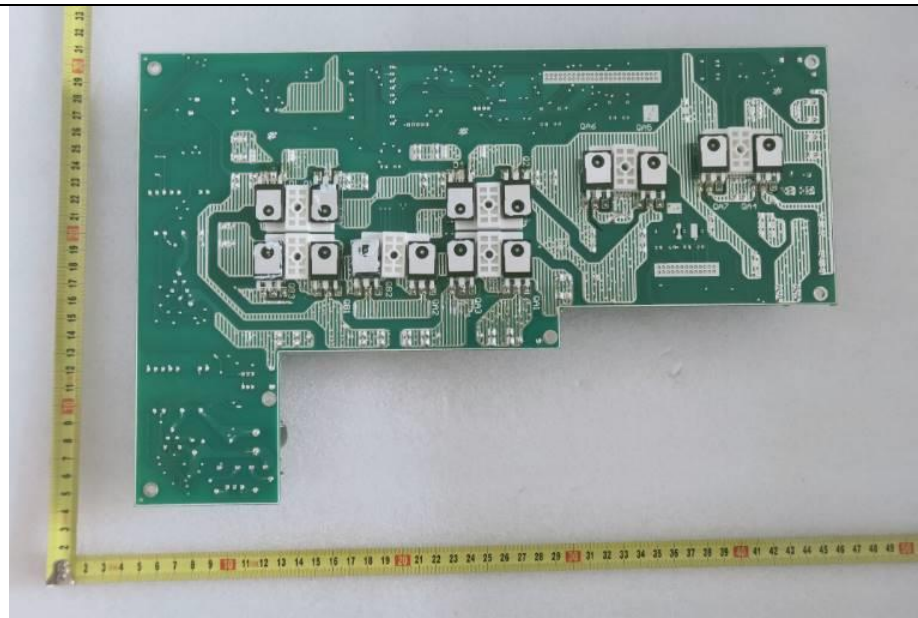



G99/1-6

Clause	Requirement - Test	Result - Remark	Verdict
--------	--------------------	-----------------	---------

Main Board – Component Side (AF6K-SH)

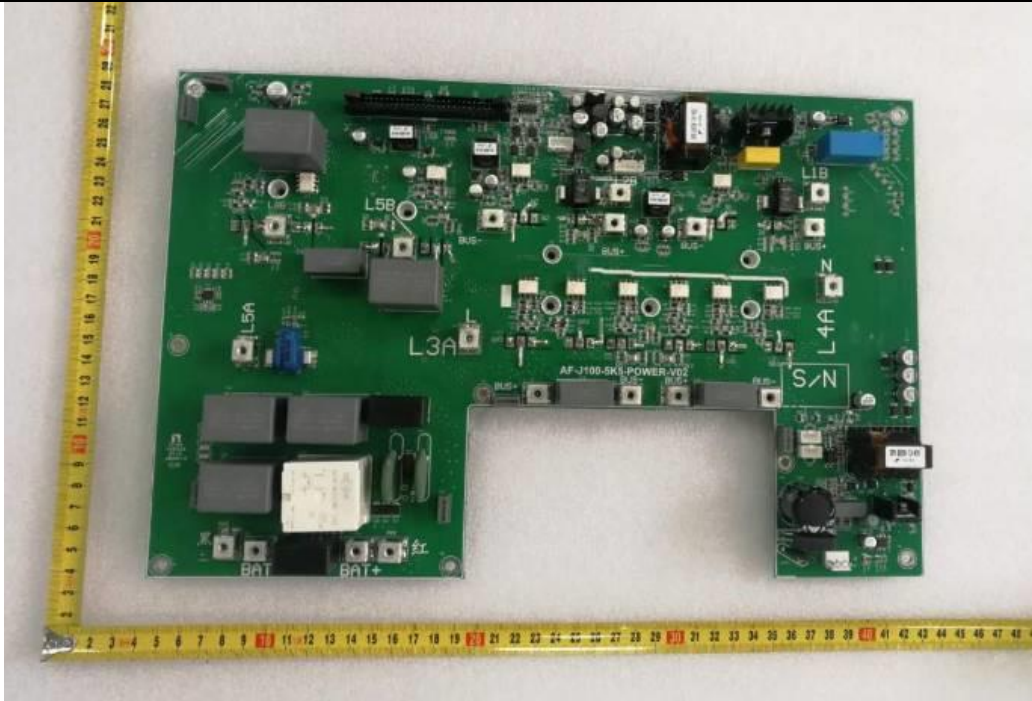

Main Board – Solder Side (AF6K-SH)

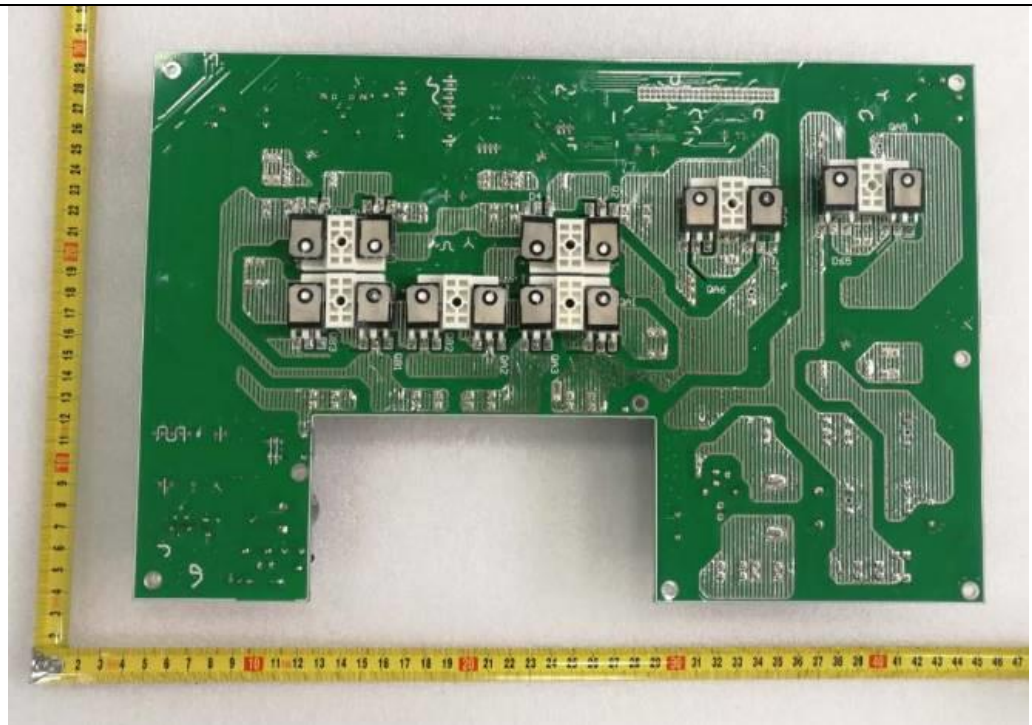



G99/1-6

Clause	Requirement - Test	Result - Remark	Verdict
--------	--------------------	-----------------	---------

Busbar capacitor Board – Component Side

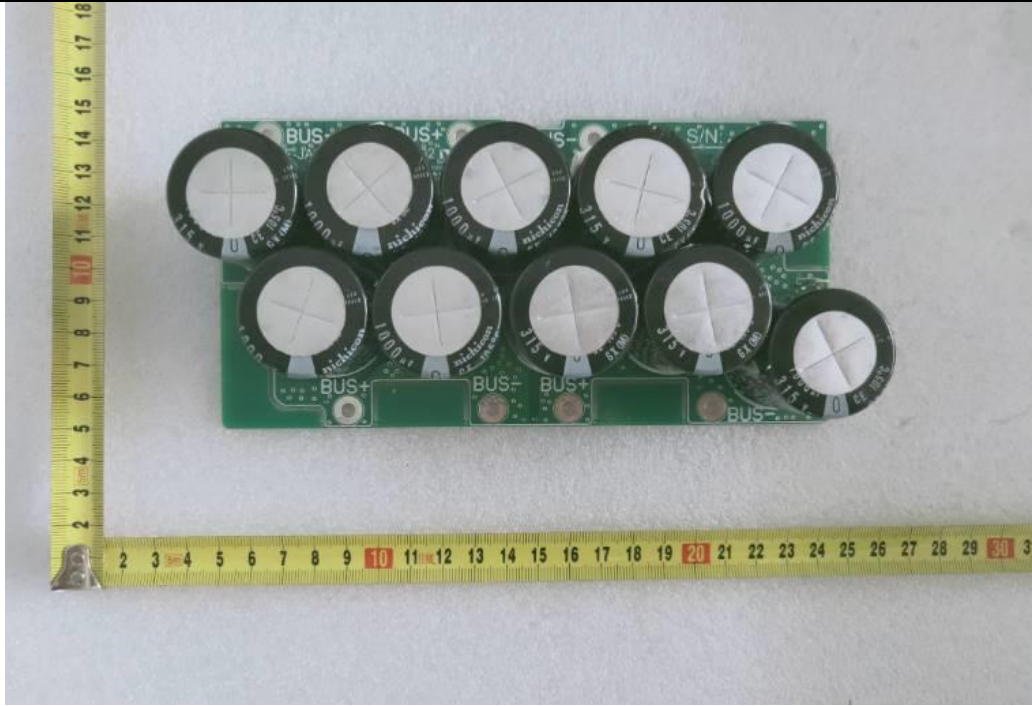

Busbar capacitor Board – Solder Side

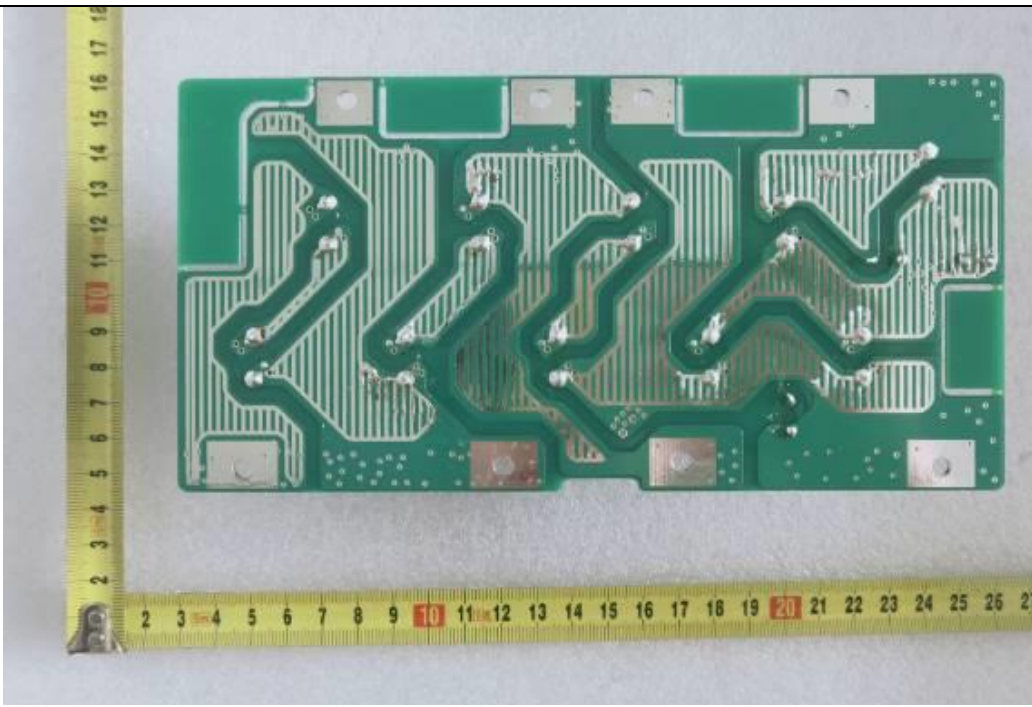

G99/1-6

Clause	Requirement - Test	Result - Remark	Verdict
--------	--------------------	-----------------	---------

Control Board – Component Side

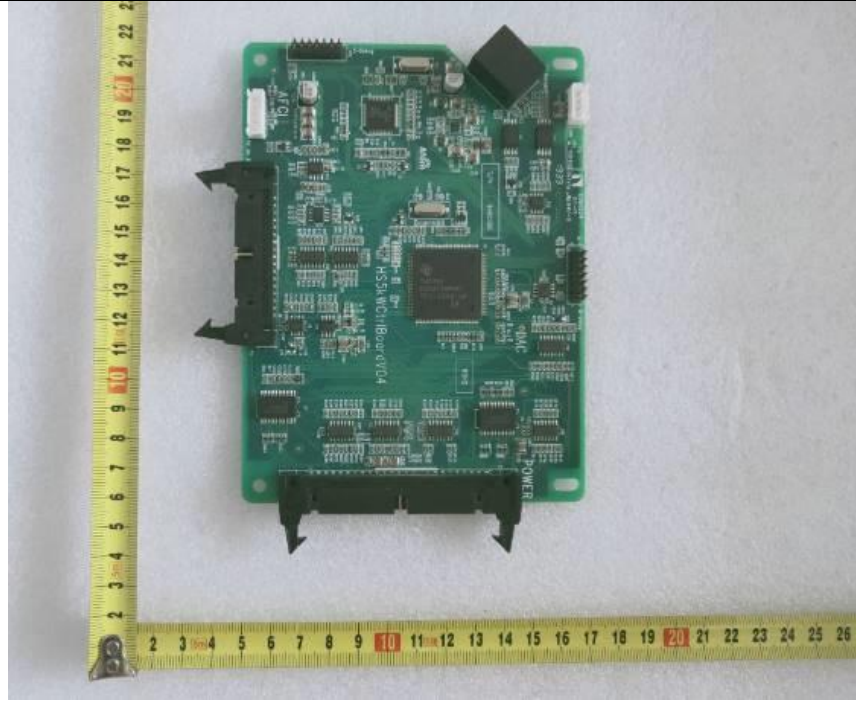

Control Board – Solder Side

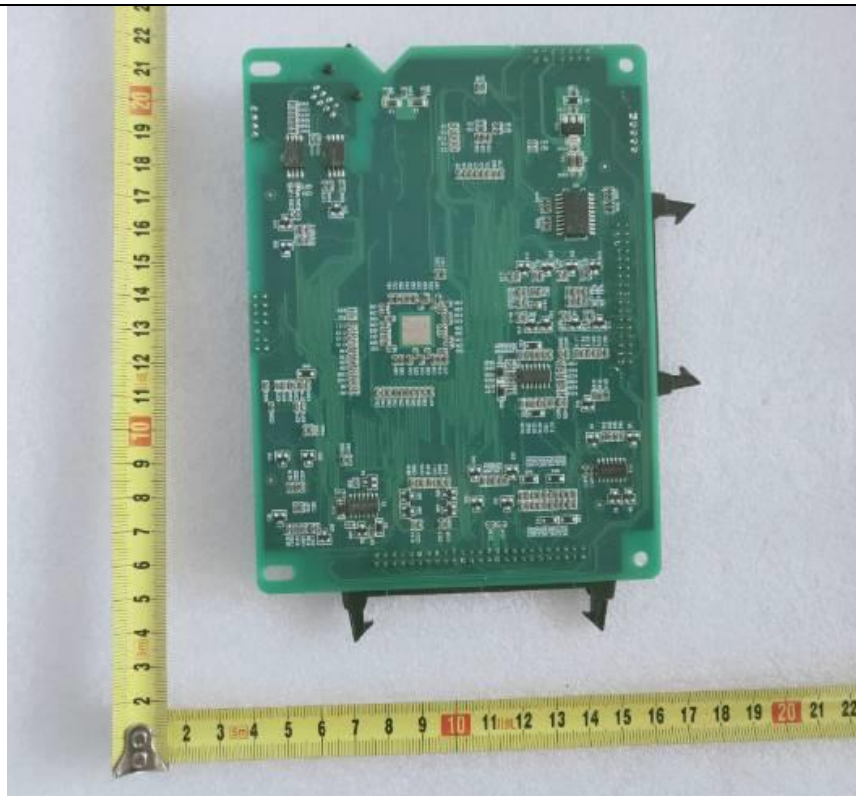

G99/1-6			
Clause	Requirement - Test	Result - Remark	Verdict

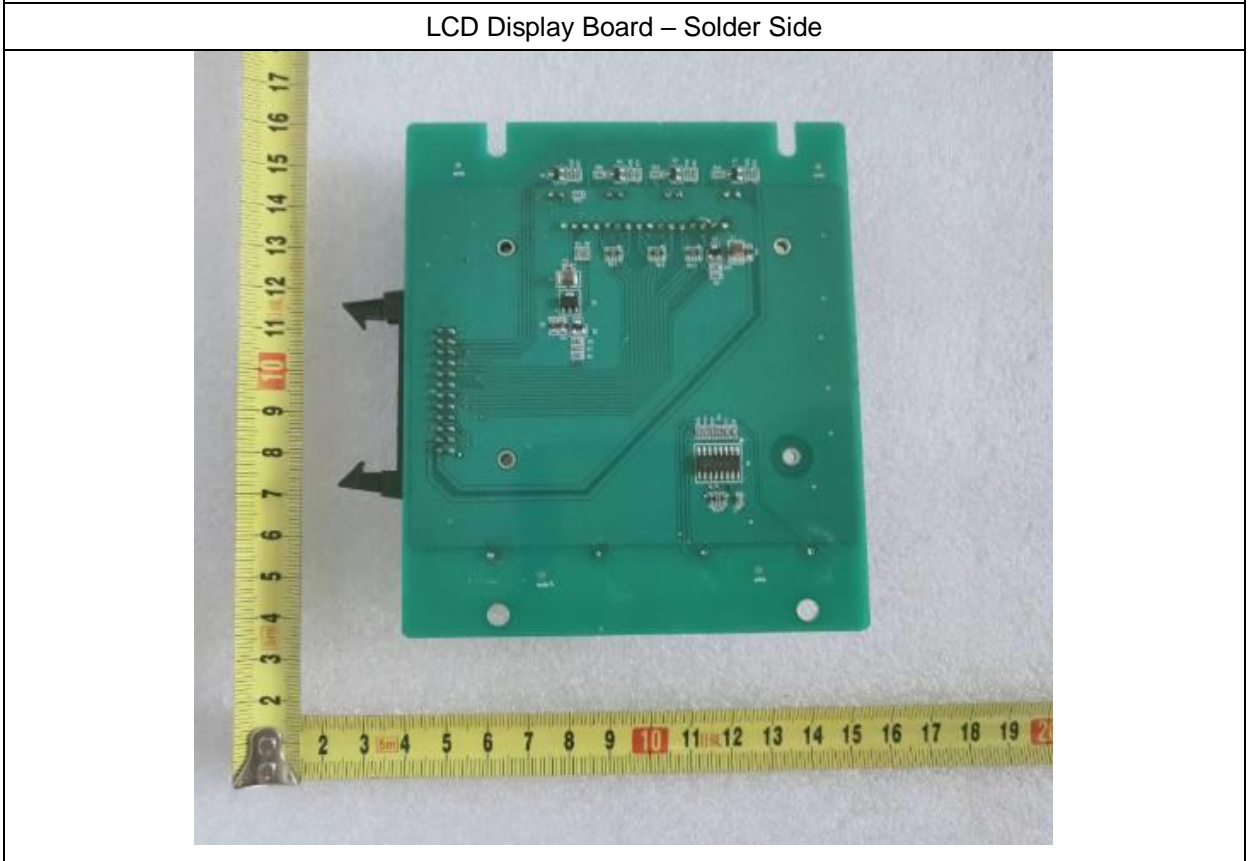
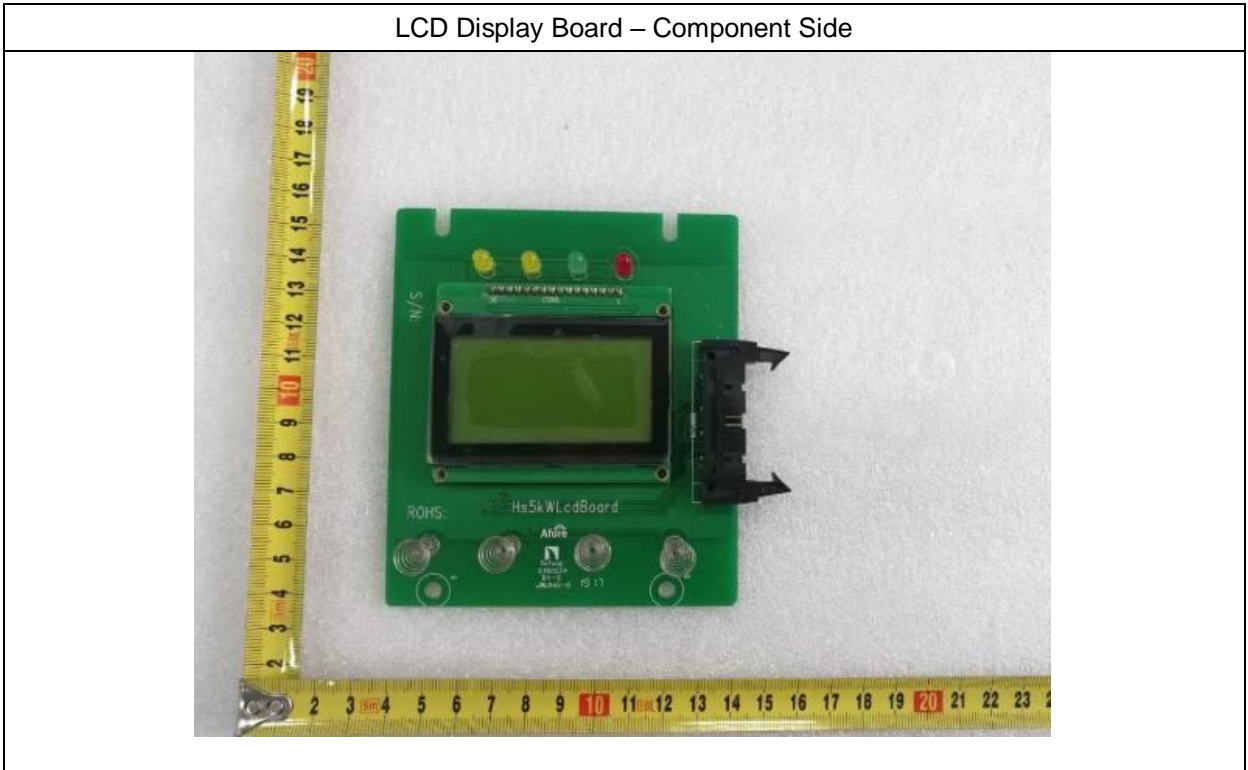



G99/1-6

Clause	Requirement - Test	Result - Remark	Verdict
--------	--------------------	-----------------	---------

EMI Board – Component Side

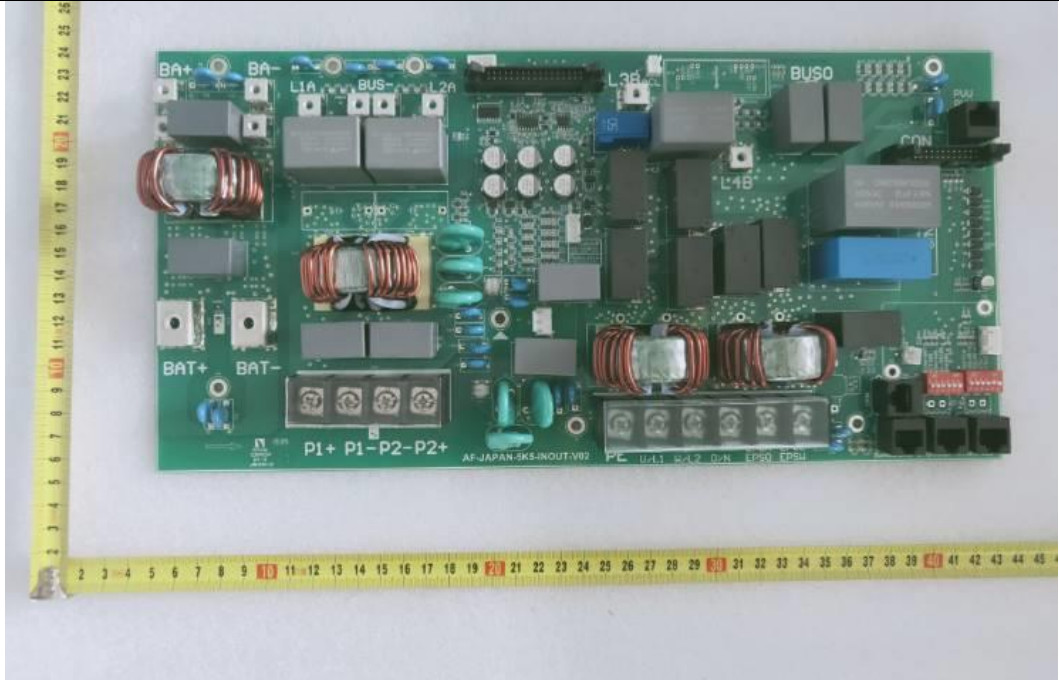

EMI Board – Solder Side

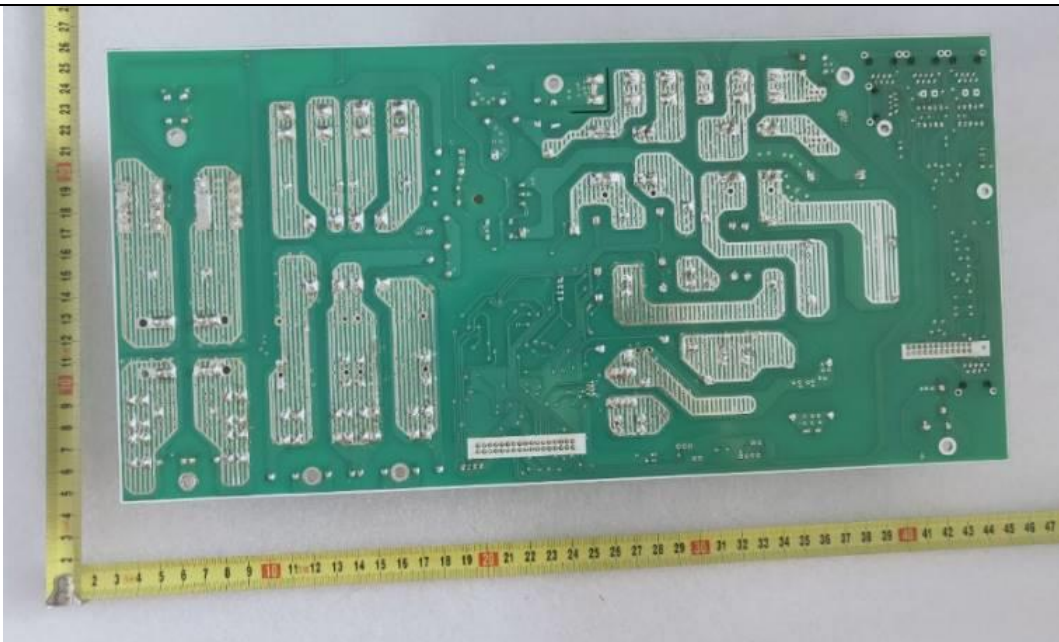

-----END-----